



EN

Wireless Weather Station with Temperature, Ice Alert and Radio- Controlled Clock

Model: BAR386

USER MANUAL

CONTENTS

- Introduction** 2
- lock Overview** 2
 - Front View 2
 - Back View 2
 - LCD Display 3
 - Remote Sensor (THN132N) 4
- Getting Started** 4
 - Batteries 4
- Remote Sensor** 4
 - Sensor Data Transmission 6
- Clock** 6
 - Clock Reception 6
 - Reception Signal 6
 - Set Clock..... 6
- Alarm**..... 7
- Weather Forecast** 7

- Temperature** 7
 - Temperature and Pressure Trend 8
 - Ice Warning 8
 - HI / LO Temperature Alarm 8
- Moon Phase** 8
- Reset** 9
- Precautions** 9
- Specifications** 9
- About Oregon Scientific** 10
- EU-Declaration of Conformity** 11



INTRODUCTION

Thank you for selecting this Oregon Scientific™ Wireless Weather Station with Temperature, Ice Alert and Radio-Controlled Clock (BAR386). This clock is supplied with a remote sensor (THN132N) and can support up to 3 sensors in total (additional sensors sold separately).

NOTE Please keep this manual handy as you use your new product. It contains practical step-by-step instructions, as well as technical specifications and warnings you should know about.

CLOCK OVERVIEW

FRONT VIEW



1. **SNOOZE**
2. **ALARM** (speaker icon): View alarm status; set alarm



BACK VIEW

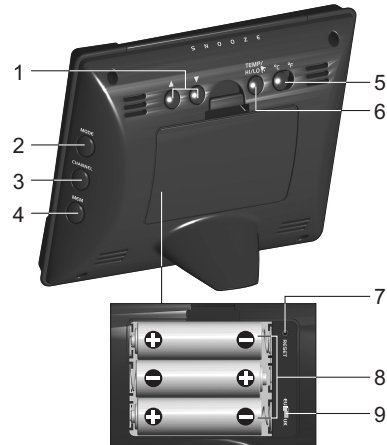



EN

1. ▲ / ▼: Increase / decrease setting; activate / deactivate clock reception signal
2. **MODE**: Change settings / display
3. **CHANNEL**: Switch remote sensor display
4. **MEM**: View current, maximum and minimum temperature / humidity
5. °C / °F: Select temperature unit
6. **TEMP HI / LO** ▶: Change settings or enable / disable hi or lo temperature alarm for channel 1
7. **RESET**: Reset unit to default settings
8. Battery compartment
9. **EU / UK** switch

1. Sensor battery low
2. Ice warning is active
3. Pressure trend
4. Weather forecast
5. Alarm set
6. AM / PM mode selected
7. Clock signal reception
8. Clock
9. Sensor reception icon
10. Hi / lo temperature alarm
11. Outdoor temperature trend
12. Outdoor temperature
13. Max / min icon
14. Main unit battery low
15. Indoor temperature trend
16. Indoor temperature
17. Max / min icon
18. Main unit sensor icon
19. Alarm mode
20. Moon phase
21. Day and month display

LCD DISPLAY

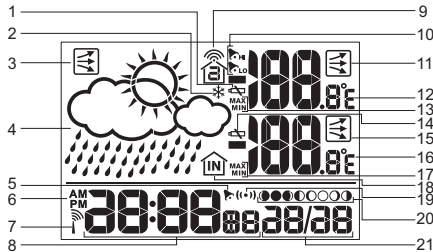

REMOTE SENSOR (THN132N)

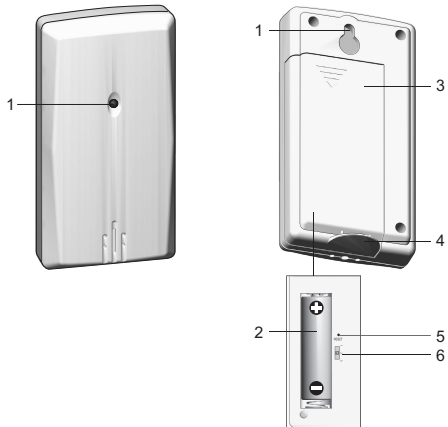

1. LED indicator

1. Wall mount
2. Battery compartment
3. Battery door
4. Table stand
5. **RESET**
6. **CHANNEL** switch

GETTING STARTED

BATTERIES

Insert batteries before first use, matching the polarity (+ and -). Press **RESET** after each battery change.

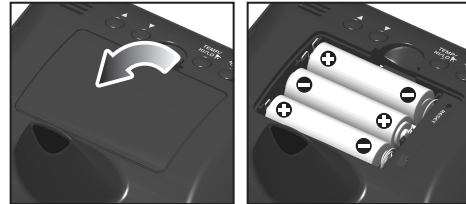

 indicates main unit batteries are low.

NOTE Do not use rechargeable batteries. We recommend that you use alkaline batteries with this product for longer usage and lithium batteries in temperatures below freezing.

REMOTE SENSOR

The sensor collects temperature readings approx. every 40 seconds and sends them to the main unit. The main unit can collect data from up to 3 sensors.

To set up the sensor:

1. Slide open the battery door.



EN

2. Insert the batteries, matching the polarity (+ / -). Press **RESET** after each battery change.
3. Select a channel. Make sure you use a different channel for each sensor.

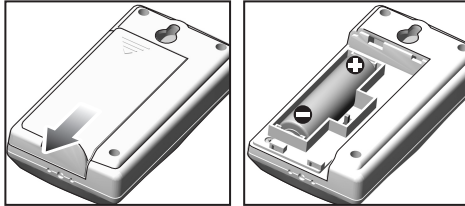

4. Close the battery compartment.
5. Secure the sensor in the desired location using the wall mount or table stand.

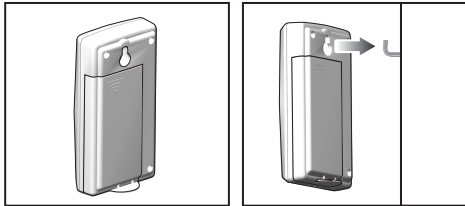

For best results:

- Place the sensor out of direct sunlight and moisture.
- Do not place the sensor more than 30 m (100 ft) from the main (indoor) unit.
- Position the sensor so that it faces the main (indoor) unit, minimizing obstructions such as doors, walls, and furniture.
- Place the sensor in a location with a clear view to the sky, away from metallic or electronic objects.
- Position the sensor close to the main unit during cold winter months as below-freezing temperatures may affect battery performance and signal transmission.



The transmission range may vary depending on many factors. You may need to experiment with various locations to get the best results.

Standard Alkaline batteries contain significant amounts of water. Because of this they will freeze in low temperatures of approximately -12°C (10°F). Disposable Lithium batteries have a much lower threshold for temperature with an estimated freezing range of below -30°C (-22°F).

Wireless ranges can be impacted by a variety of factors such as extremely cold temperatures. Extreme cold may temporarily reduce the effective range between the sensor and the base station. If the unit's performance fails due to low temperature, the unit will resume proper functioning as the temperature rises to within the normal temperature range (i.e. no permanent damage will occur to the unit due to low temperatures).

SENSOR DATA TRANSMISSION

The sensor reception icon in the remote sensor area shows the status.

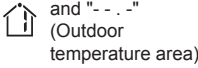
ICON	DESCRIPTION
	Main unit is searching for the sensor(s)
	A channel has been found and sensor signal is being received
	The sensor cannot be found. Search for the sensor or check batteries

To search for a sensor:

Simultaneously, press and hold **MEM** and **CHANNEL** for 2 seconds.

NOTE If the sensor is still not found, check the batteries, obstructions, and remote unit location.

CLOCK

CLOCK RECEPTION

This product is designed to synchronize its date and time automatically once it is within range of:

- DCF-77 generated from Frankfurt, Germany for Central Europe.
- MSF-60 generated from Rugby, England.





The clock collects the radio signals whenever it is within 1500 km (932 miles) of a signal.

NOTE Slide the **EU / UK** switch to appropriate position for your location. Repeat each time you reset the unit.

NOTE Initial reception takes 2-10 minutes for first set up or when **RESET** is pressed. Once complete, the reception icon will stop blinking. If the signal is weak, it can take up to 24 hours to get a valid signal.

RECEPTION SIGNAL

Clock signal reception indicator:

STRONG SIGNAL	WEAK SIGNAL	NO SIGNAL
		

To enable and force a signal search:

Press and hold ▲ for 2 seconds.

To disable the signal reception:

Press and hold ▼ for 2 seconds.

SET CLOCK

If the clock signal reception is enabled and a signal is being received the clock does not need to be manually set.

1. Press and hold **MODE** for 2 seconds.
2. Press ▲ or ▼ to change the settings.



EN

3. Press **MODE** to confirm.
4. The settings order is: time zone offset, hour, minute, year, month, day and language.

NOTE The time zone offset can be used to set the clock up to + / - 9 hours from the received clock signal time. If you have disabled the clock signal reception (i.e. manually setting the clock), do not set a value for time zone offset.

NOTE The language options are (E) English, (D) German, (F) French, (I) Italian, and (S) Spanish.

Press **MODE** to choose between the clock with seconds and clock with weekday display modes.

ALARM

To set the alarm:

1. Press and hold **ALARM** for 2 seconds.
2. Press **▲** / **▼** to set hour / minute.
3. Press **ALARM** to confirm.  indicates alarm is ON.

To toggle alarms ON / OFF:





1. Press **ALARM** to display alarm time.
2. Press **ALARM** again to turn alarm ON / OFF.

To silence the alarm:

- Press **SNOOZE** to silence it for 8 minutes.
- OR
- Press any key except **SNOOZE** to turn the alarm off and activate it again after 24 hours.

WEATHER FORECAST

This product forecasts the next 12 to 24 hours of weather within a 30-50 km (19-31 mile) radius based on barometric pressure trend readings.

ICON	DESCRIPTION
	Clear
	Partially Cloudy
	Cloudy
	Rainy

NOTE The maximum operating altitude for weather forecast is 2500 m (8202 ft).

TEMPERATURE

To toggle temperature unit:

Press **°C** / **°F**.

To view outdoor sensors temperature readings:

Press **CHANNEL**.

To auto-scan between sensors:

Press and hold **CHANNEL** for 2 seconds. Each sensor's data is displayed for 3 seconds.

EN

To end auto-scan:

Press **CHANNEL** or **MEM**.

To toggle between current, minimum and maximum records for the selected sensor:



Press **MEM** repeatedly.

To clear the records:

Press and hold **MEM** for 2 seconds.

TEMPERATURE AND PRESSURE TREND

The temperature and pressure trend icons are based on recent sensor readings.

RISING	STEADY	FALLING
		

ICE WARNING

If the channel 1 sensor falls between 3°C to -2°C (37°F to 28°F), * flashes to warn you that the temperature is approaching freezing.

NOTE The warning will automatically stop if the temperature goes outside the ice-warning range.

HI / LO TEMPERATURE ALARM

An alert can be set to sound if the sensor set to channel 1 records above or below a temperature of your choice.

To set alarm ON / OFF:









1. Press and hold **TEMP HI / LO**.
2. Use **▲** and **▼** to select high / low temperature alarm. Press **TEMP HI / LO** to confirm.
3. Press **▲** / **▼** to set alarm **ON** / **OFF** and press **TEMP HI / LO** to confirm.
4. If alarm has been activated, use **▲** and **▼** to select the temperature.
5. Press **TEMP HI / LO** to confirm.

To silence the hi / lo temperature alarm:

Press any key. The alarm resets automatically and will resound if the hi / lo temperature is exceeded again.

MOON PHASE

- When calendar is set press **▲** or **▼** to view the moon phase for the next/previous day.
- Press and hold **▲** or **▼** to scan through the years (2001 to 2099).

	New Moon
	Waxing Crescent
	First Quarter
	Waxing Gibbous
	Full Moon
	Waning Gibbous
	Last Quarter
	Waning Crescent



EN

RESET

Press **RESET** to return the unit to the default settings.

PRECAUTIONS

This product is engineered to give you years of satisfactory service if you handle it carefully. Here are a few precautions:

- Do not subject the unit to excessive force, shock, dust, temperature or humidity, which may result in malfunction, shorter electronic life span, damaged battery and distorted parts.
- Do not immerse the unit in water. If you spill liquid over it, dry it immediately with a soft, lint-free cloth.
- Do not clean the unit with abrasive or corrosive materials.
- Do not tamper with the unit's internal components. Doing so will invalidate the warranty on the unit and may cause unnecessary damage. The unit contains no user-serviceable parts.
- Only use fresh batteries as specified in the user's instructions. Do not mix new and old batteries.
- Due to printing limitations, the displays shown in this manual may differ from the actual display.
- The contents of this manual may not be reproduced without the permission of the manufacturer.
- Do not dispose this product as unsorted municipal waste. Collection of such waste separately for special treatment is necessary.

NOTE The technical specifications for this product and the contents of the user manual are subject to change without notice.

SPECIFICATIONS

TYPE	DESCRIPTION
MAIN UNIT	
L x W x H	130 x 55 x 112 mm (5.1 x 2.1 x 4.4 in)
Weight	176 g (6.2 oz) without batteries
Temperature unit	°C / °F
Temperature range	-5°C to 50°C (23°F to 122°F)
Resolution	0.1°C (0.2°F)
Clock frequency	DCF-77 (EU) / MSF-60 (UK)
Synchronization	Auto or disabled
Signal frequency	433 MHz
Clock	Auto or manual (disabled)
Humidity range	25% - 95%
Humidity resolution	1%
Memory	Min / Max relative humidity and temperature
Alarm duration	2 minutes
Snooze	8 minutes
Clock display	HH:MM:SS HH:MM: Day of Week
Hour format	12 / 24 hour format

EN

Calendar	DD / MM language selectable: E, F, D, I and S
Power	3 x UM-3 (AA) 1.5 V batteries
REMOTE UNIT	
L x W x H	96 x 50 x 22 mm (3.8 x 2.0 x 0.9 in)
Weight	62 g (2.22 oz) without battery
Transmission range	30 m (100 ft) unobstructed
Temperature range	-30°C to 60°C (-22°F to 140°F)
Power	1 x UM-3 (AA) 1.5 V batteries

NOTE We recommend that you use alkaline batteries with this product for longer usage and lithium batteries in temperatures below freezing.

ABOUT OREGON SCIENTIFIC

Visit our website (www.oregonscientific.com) to learn more about Oregon Scientific products such as digital cameras; MP3 players; children's electronic learning products and games; projection clocks; health and fitness gear; weather stations; and digital and conference phones. The website also includes contact information for our Customer Care department in case you need to reach us, as well as frequently asked questions and customer downloads.

We hope you will find all the information you need on our website, however if you're in the US and would like to contact the Oregon Scientific Customer Care department directly, please visit:

www2.oregonscientific.com/service/default.asp

OR

Call 1-800-853-8883.

For international inquiries, please visit:

www2.oregonscientific.com/about/international.asp



EN

EU-DECLARATION OF CONFORMITY

Hereby, Oregon Scientific, declares that the Wireless Weather Station with Temperature, Ice Alert and Radio-Controlled Clock (Model BAR386) is in compliance with the essential requirements and other relevant provisions of Directive 1999/5/EC.

A copy of the signed and dated Declaration of Conformity is available on request via our Oregon Scientific Customer Service.



COUNTRIES RTTE APPROVAL COMPLIED

All EU Countries, Switzerland 
and Norway 