



21

CONTENTS

Contents	1	Weather Forecast	12
Introduction	2	Temperature	13
Product Overview	2	Select Temperature Unit	13
Front View	2	Minimum / Maximum Records	13
Back View	3	Moon Phase	13
LCD Display	4	Backlight	13
Remote Sensor (THN122N)	5	Reset System	14
Getting Started	6	Projection Unit	14
Batteries	6	Safety and Care	14
AC Adaptor	7	Warnings	14
Change Settings	7	Troubleshooting	15
Remote Sensor (THN122N)	8	Specifications	16
Setup Sensor	8	Main Unit Dimensions	16
Data Transmission	9	Remote Sensor Dimensions	16
Search for Sensor	10	Temperature	16
Clock	10	Remote Sensor (THN122N)	16
Turn Clock ON / OFF	10	Clock / Projector	16
Set Clock / Calendar	11	Power	17
Switch Clock Display	11	About Oregon Scientific	17
Alarm	11	EC-Declaration of Conformity	18
View Alarm Settings	11		
Set Alarm	11		
Activate Alarm	11		
Silence Alarm	12		

INTRODUCTION

Thank you for selecting the Oregon Scientific™ Wireless Weather Station (BAR623P / BAR623PU). This device bundles precise time keeping with a projection clock, weather forecast, and indoor and outdoor temperature monitoring features into a single tool you can use from the convenience of your home.

In this box, you will find:

- Main unit with projection clock
- Main unit batteries, 3 x UM-3 (AA) 1.5V
- Main unit 4.5V AC / DC adaptor with jack
- Remote sensor (THN122N)
- Remote sensor batteries, 2 x UM-4 (AAA) 1.5V

Keep this manual handy as you use your new product. It contains practical step-by-step instructions, as well as technical specifications and warnings you should know.

PRODUCT OVERVIEW

FRONT VIEW



1. **SNOOZE / LIGHT** button
2. ▲ and ▼ : Increase or decrease setting / activate or deactivate RF Clock
3. **MODE**: Change display / settings
4. ((•)) : View alarm status; set alarm
5. 🔔 : Press to activate or deactivate alarm
6. Clock and outdoor temperature projector unit
7. **LCD display**



EN

BACK VIEW

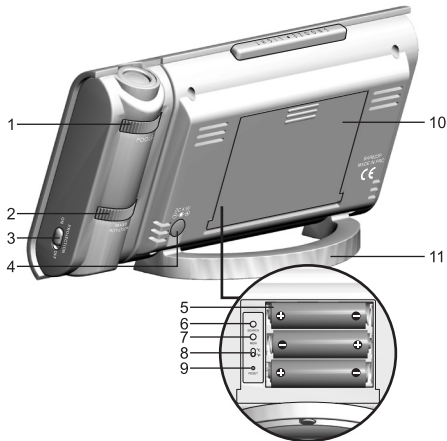

1. Projector **FOCUS** knob
2. Projector **IMAGE ROTATION** knob
3. **PROJECTION ON / OFF** switch
4. AC / DC adaptor plug cover
5. Battery compartment (cover off)
6. **SEARCH** button to locate the remote sensor
7. **MEM**: View current, maximum, and minimum temperature readings
8. °C / °F switch
9. **RESET** hole
10. Battery compartment (cover on)
11. Fixed table stand

EN

LCD DISPLAY

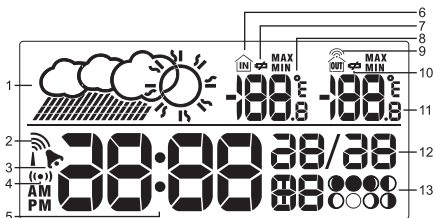

1. Weather display
2. Radio Frequency (RF) reception icon
3. Alarm activated
4. Alarm setting
5. Time
6. Indoor temperature
7. Low battery icon for main unit
8. °C / °F (Outdoor temperature)
9. Sensor signal
10. Low battery icon for sensor
11. Outdoor temperature
12. Calendar
13. Moon Phase



EN

REMOTE SENSOR (THN122N)



1. LED status indicator

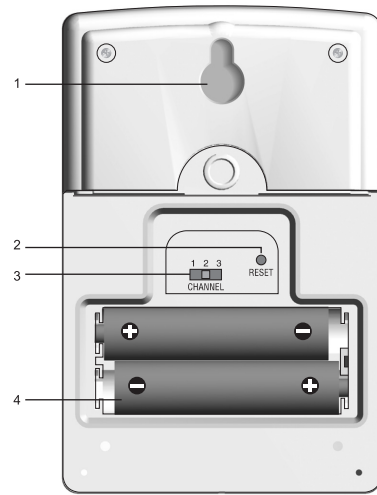

- 1. Wall mount hole
- 2. **RESET** hole
- 3. **CHANNEL** number (1-3)
- 4. Battery compartment
(Battery compartment cover not shown)

GETTING STARTED

BATTERIES

Batteries are supplied with this product:

Main unit 3 x UM-3 (AA) 1.5V batteries
Remote unit 2 x UM-4 (AAA) 1.5V batteries

Insert batteries before first use, matching the polarity (+ and -) as shown in the battery compartment. For best results, install batteries in the remote sensor before the main unit. Press **RESET**  each battery change.

NOTE Do not use rechargeable batteries.

 **shows** when batteries are low.

NOTE It is recommended that you use alkaline batteries with this product for longer performance.

Installing the batteries:

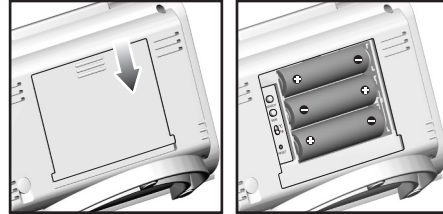

UNIT	 LOCATION
Main	Indoor Temperature Area
Remote	Outdoor Temperature Area



2

AC ADAPTOR

The main unit has a 4.5V AC / DC adaptor with jack, which provides continuous clock / temperature projection.

Inserting the adaptor:

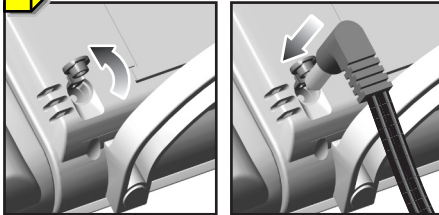

CHANGE SETTINGS

To change, time, calendar and language settings:

1. Press and hold **MODE** for 2 seconds to enter setting mode.
2. Press **▲** or **▼** to change settings. (To reach the setting you want quickly, press and hold **▲** or **▼**.)
3. Press **MODE** to confirm.

REMOTE SENSOR (THN122N)

This product is shipped with a THN122N Thermometer Sensor that collects Temperature data. The main unit can be connected to only 1 remote sensor.

SETUP SENSOR

1. Open the remote sensor battery compartment with a small Phillips screwdriver.
2. Insert the batteries, matching the polarity (+ and -) as shown in the battery compartment.
3. Set the channel switch to any channel. The switch is located in the battery compartment.
4. Place the sensor near the main unit. Press **RESET** on the sensor. Then, press and hold **SEARCH** on the main unit to initiate signal sending between the sensor and the main unit. The reception icon on the main unit will blink for approximately 3 minutes while it is searching for the sensor. (Refer to the Sensor Data Transmission section for more information.)
5. Close the remote sensor battery compartment.
6. Secure the sensor in the desired location using the wall mount or table stand.

Installing the batteries:

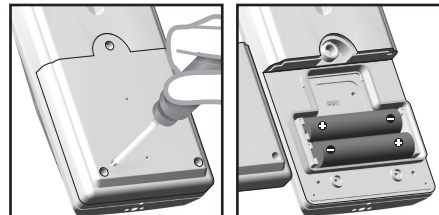

Using the stand or wall mount:

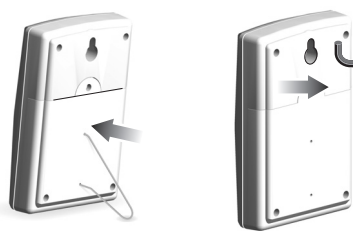



EN

For best results:

- Insert the batteries and select the channel before you mount the sensor.
- Place the sensor out of direct sunlight and moisture.
- Do not place the sensor more than 30 metres (98 feet) from the main (indoor) unit.
- Position the sensor so that it faces the main (indoor) unit, minimizing obstructions such as doors, walls, and furniture.
- Place the sensor in a location with a clear view to the sky, away from metallic or electronic objects.
- Position the sensor close to the main unit during cold winter months as below-freezing temperatures may affect battery performance and signal transmission.

You may need to experiment with various locations to get the best results.

DATA TRANSMISSION

Data is sent from the sensor every 40 seconds. The reception icon shown in the Temperature Area shows the status.

ICON	DESCRIPTION
	Main unit is searching for the sensor
	A Channel has been found
--- show in Outdoor Temp Area	The sensor cannot be found. Search for the sensor or check batteries

SEARCH FOR SENSOR

To search for the sensor, press and hold **SEARCH** for 2 seconds.

NOTE If the sensor is still not found, check the batteries, obstructions, and remote unit location.

NOTE Signals from household devices such as doorbells, electronic garage doors, and home security systems may cause temporary reception failure. This is normal and does not affect general product performance. The reception will resume once the interference ends.

CLOCK

The clock automatically synchronizes the current time and date when it is brought within range of the radio signal DCF77 generated from Frankfurt, Germany for Central Europe (model BAR623P) or MSF60 generated from Rugby, England (model BAR623PU).

NOTE The signals are collected by the main unit when it is within 1500 km (932 miles) of a signal.

Initial reception takes 2-10 minutes, and is initiated when you first setup the unit, and whenever you press **RESET**.

Once complete, the reception icon will stop blinking. The icon is shown in the Clock Area.

STRONG SIGNAL	WEAK SIGNAL	NO SIGNAL
		

To force a manual search for clock signals, press and hold **▲** for 2 seconds. If no signal is found, check the batteries.

TURN CLOCK ON / OFF

Perform this step if you cannot receive clock signals. Press and hold **▼** for 2 seconds. Then, manually set the clock following the "Set Clock" instructions (below).



The signal icon indicates that the clock feature is ON. No icon means that it is OFF.



m

SET CLOCK / CALENDAR

You only need to do this if you have disabled the clock feature (for example, if you are too far from or cannot receive a signal).

1. Press and hold **MODE** for 2 seconds. The Clock Area will blink.
2. Select the hour, minute, year, month, day, and day of the week language. Press ▲ or ▼ to change the setting.
3. Press **MODE** to confirm.

The language options are (E) English, (F) French, (D) German, (I) Italian, and (S) Spanish.

SWITCH CLOCK DISPLAY

Press **MODE** to toggle between Clock with Seconds and Clock with Weekday display.

ALARM

This product is equipped with a 2-minute crescendo alarm.



VIEW ALARM SETTINGS

Press **((•))**. The alarm time and status will show in the Clock Area.

SET ALARM

1. Press **((•))** to switch to alarm display.
2. Press and hold **((•))** again for 2 seconds. The alarm settings will blink.
3. Select the hour and minute. Press ▲ or ▼ to change settings. Press **((•))** to confirm.

ACTIVATE ALARM

Press  to activate or deactivate the alarm.  shows in the Clock / Alarm Area when the alarm is activated.

SILENCE ALARM

When the alarm time is reached, the crescendo alarm will sound for 2 minutes. To silence the alarm:

- Press **SNOOZE** to silence it for 8 minutes.





OR

- Press any key except **SNOOZE** to mute the alarm and activate it again after 24 hours.

If no button is pressed, the alarm will automatically silence after 2 minutes. It will then sound again after 8 minutes.

WEATHER FORECAST

This product forecasts the next 12 to 24 hours of weather within a 30-50 km (19-31 mile) radius with 70 to 75 percent accuracy. The weather forecast is always displayed.

SUNNY	PARTLY CLOUDY	CLOUDY	RAINY
			



MEM

TEMPERATURE

This product can display current, minimum, and maximum temperature information collected by the remote sensor and main (indoor) unit.

Outdoor data is collected and displayed every 40 seconds. Indoor data is collected and displayed every 10 seconds.

SELECT TEMPERATURE UNIT

Slide the °C / °F switch into the desired location. The switch is located in the main unit battery compartment. The setting for the main unit overrides the remote sensor setting.

MINIMUM / MAXIMUM RECORDS

The **MEM** button is located in the main unit battery compartment. Press **MEM** to toggle between current, maximum (MAX) and minimum (MIN) records. To clear the records, press and hold **MEM** for 2 seconds. A beep will sound to confirm that the memory has been cleared.

MOON PHASE

The Calendar must be set for this feature to work, see "Set Clock" section.

- Press ▲ or ▼ to view the moon phase for the next or previous day.
- Press and hold ▲ or ▼ to scan quickly through the years (2001 to 2099).

	New Moon
	Waxing Crescent
	First Quarter
	Waxing Gibbous
	Full Moon
	Waning Gibbous
	Last-quarter
	Waning Crescent



BACKLIGHT

Press **SNOOZE / LIGHT** to activate the backlight for 8 seconds.

RESET SYSTEM

The **RESET** button is located in the main unit battery compartment. Press **RESET** when you change the batteries and whenever performance is not behaving as expected (for example, unable to establish radio frequency link with remote sensor or clock).

PROJECTION UNIT

The projection unit can display both time and outdoor temperature. To use this feature:

- Press the **SNOOZE / LIGHT** button to project the time and outdoor temperature for 8 seconds.

OR

- Slide the **PROJECTION** switch to **ON** to activate continuous projection. However, this function will not work unless the AC / DC adaptor is used.

You can also:

- Adjust the **FOCUS** knob to make the image clearer.
- Adjust the **IMAGE ROTATION** knob to rotate the image clockwise or anti-clockwise.
- Manually tilt the projection unit to position the image vertically upwards or downwards.

SAFETY AND CARE

Clean the product with a slightly damp cloth and alcohol-free, mild detergent. Avoid dropping the product or placing it in a high-traffic location.

WARNINGS

This product is designed to give you years of service if handled properly. Oregon Scientific will not be responsible for any deviations in the usage of the device from those specified in the user instructions or any unapproved alterations or repairs of the product. Observe the following guidelines:



- Never immerse the product in water. This can cause electrical shock and damage the product.
- Do not subject the main unit to extreme force, shock, or fluctuations in temperature or humidity.
- Do not tamper with the internal components.
- Do not mix new and old batteries or batteries of different types.
- Do not use rechargeable batteries with this product.
- Remove the batteries if storing this product for a long period of time.
- Do not scratch the LCD display.

NOTE The technical specification of this product and contents of this user guide are subject to change without notice. Images not drawn to scale.

TROUBLESHOOTING

PROBLEM	SYMPTOM	REMEDY
Calendar	Strange date / month	Change language (→ 11)
Clock	Cannot adjust clock	Disable clock (→ 10)
	Cannot auto-synchronize the date and time	1. Adjust batteries (→ 6) 2. Press RESET (→ 14) 3. Manually activate clock feature (→ 11) temperature is out-of-range
Temp	Shows 'LLL' or 'HHH'	Check batteries (→ 8)
Remote sensor	Cannot locate remote sensor	Check location (→ 9)
	Data does not match main unit	initiate a manual sensor search (→ 10)

SPECIFICATIONS

MAIN UNIT DIMENSIONS

L x W x H 92 x 167 x 53 mm
(3.6 x 6.6 x 2.1 inches)

Weight **228 grams (8.04 ounces)**
without battery

REMOTE SENSOR DIMENSIONS

L x W x H 92 x 60 x 20 mm
(3.6 x 2.4 x **0.79** inches)

Weight 63 grams (2.22 ounces)
without battery

TEMPERATURE

Unit °C / °F

Indoor range **-5°C to 50°C**
(**23°F to 122°F**)

Outdoor range **-20°C to 60°C**
(**-4°F to 140°F**)

Resolution **0.1°C (0.2°F)**

Display

Rainy, cloudy, partly
cloudy, sunny

REMOTE SENSOR (THN122N)

RF frequency 433 MHz

Range 30 metres (98 feet)
with no obstructions

Transmission Every 40 seconds

Channel No. 1

CLOCK / PROJECTOR

RF Clock Auto or manual (disabled)

Clock display HH:MM:SS

Hour format 12hr AM / PM
(Model BAR623PU)
24hr (Model BAR623P)



Calendar	DD / MM; weekday in 5 languages (E, D, F, I, S)
Alarm	Single alarm with 2-minute crescendo and 8-minute Snooze
Projector	Outdoor temperature and time

POWER

Main unit batteries	3 x UM-3 (AA) 1.5V
Sensor batteries	2 x UM-4 (AAA) 1.5V
AC / DC adaptor	4.5V with jack

NOTE It is recommended that you use alkaline batteries with this product for longer performance.

ABOUT OREGON SCIENTIFIC

Visit our website (www.oregonscientific.com) to learn more about Oregon Scientific products such as digital cameras; MP3 players; children's electronic learning products and games; projection clocks; health and fitness gear; weather stations; and digital and conference phones. The website also includes contact information for our customer care department in case you need to reach us, as well as frequently asked questions and customer downloads.

We hope you will find all the information you need on our website, however if you'd like to contact the Oregon Scientific Customer Care department directly, please visit www2.oregonscientific.com/service/support or call 949-608-2848 in the US. For international enquiries, please visit www2.oregonscientific.com/about/international/default.asp.



EC-DECLARATION OF CONFORMITY

This product contains the approved transmitter module that complies with the essential requirements of Article 3 of the R&TTE 1999 / 5 / EC Directive, if used as intended and the following standards have been applied:

Safety of information technology equipment

(Article 3.1.a of the R&TTE Directive)

Applied Standard **EN 60950: 2000**

Electromagnetic compatibility

(Article 3.1.b of the R&TTE Directive)

Applied Standards
ETSI EN 301 489-1-3 (Ver.1.4.1): 2002-08

Efficient use of radio frequency spectrum

(Article 3.2 of the R&TTE Directive)

Applied Standards
ETSI EN 300 220-3 (Ver1.1.1): 2000-09

Additional information:

The product herewith complies with the requirements of the Low Voltage Directive 73 / 23 / EC, the EMC Directive 89 / 336 / EC and carries the CE marking accordingly.



Carmelo Cubito
Agrate Brianza (MI) / Italy January 2004
Manufacturer's EU R&TTE Representative



COUNTRIES RTTE APPROVAL COMPLIED

All EC countries, Switzerland ^(E)
and Norway ^(N)



Wireless Weather Station
Model: BAR623P / BAR623PU
User Manual