

LONG-RANGE WIRELESS WEATHER STATION

WITH IN-OUT THERMO-HYGROMETER AND RF CLOCK

MODEL : BAR898HG

USER'S MANUAL

INTRODUCTION

Congratulations on your purchase of the BAR898HG Long-Range Wireless Weather Station with In-Out Thermo-Hygrometer and RF Clock. This unit is an all-in-one weather forecasting device which has multiple weather-related functions. Also, with an internal antenna the reception range of this unit can be up to 100 meters.

In addition to indoor temperature and humidity, by means of wireless remote thermo-hygro sensor it can simultaneously monitor temperatures and humidities in up to 3 remote locations. The unit will show temperature and humidity trends as well as record maximum and minimum temperature and humidity readings.

As part of the weather forecasting function, the unit has a built-in barometer that displays atmospheric pressure. Using kinetic-movement graphic illustrations the unit displays atmospheric pressure trends and displays forecasts as sunny, partly cloudy, cloudy, rainy and snowy.

This unit is also a Radio Frequency (RF) controlled clock. It can automatically synchronize its current time and date when it is brought within an approximate 1500-km radius of the radio signal DCF77 generated from Frankfurt, Germany.

Other features of BAR898HG include LCD and key-panel backlight, rotatable display unit for multi-angle viewing and a Daily crescendo alarm and Pre-alarm function with an eight-minute snooze function.

No wire installation is required between the main and remote units as this unit operates at 433 MHz.

FEATURES : MAIN UNIT

A. LCD DISPLAY

A1. WEATHER FORECAST WINDOW

- Graphically illustrates a weather forecast
- Indicates trends in atmospheric pressure
- Indicates when main unit battery is low

A2. TEMPERATURE WINDOW

- Displays current, minimum or maximum indoor and remote temperature
- Indicates temperature trend

A3. HUMIDITY WINDOW

- Displays current, minimum or maximum indoor and remote humidity
- Indicates humidity trend
- Displays the Comfort Level
- Indicates when the battery of the remote sensor is low

A4. ATMOSPHERIC PRESSURE WINDOW

- Displays the current or historical (last 24 hours) barometric reading

A5. TIME / DATE / ALARM WINDOW

- Displays the current time, date (day, month, and year), daily alarm or Pre-alarm function
- Radio Frequency (RF) status indicator []

B. CONTROL BUTTONS - FRONT PANEL

B1. [MODE] BUTTON

- Changes the display mode of the clock, and alters time/date setting

B2. [/ *] BUTTON

- Displays the daily alarm time and Pre-alarm time period, or changes the corresponding alarm time

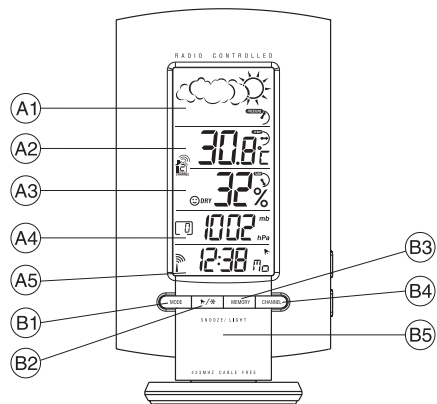

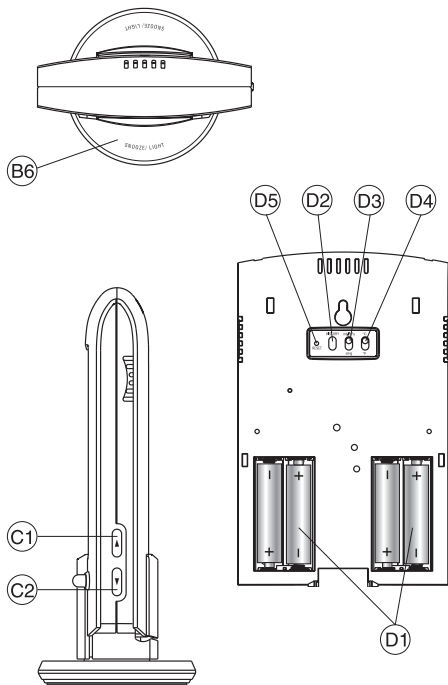

B3. [MEMORY] BUTTON

- Displays minimum and maximum temperature and humidity readings, and erases memory data

B4. [CHANNEL] BUTTON

- Displays the temperature and humidity readings of the indoor or remote sensor

B5. [SNOOZE / LIGHT] BUTTON

- Activates the snooze function or turn on the backlight

B6. DETACHABLE TABLE - STAND ([SNOOZE / LIGHT] STAND - BUTTON)

- Acts as the [SNOOZE / LIGHT] BUTTON when attached to the display unit

C. CONTROL BUTTONS - SIDE PANEL

C1 & C2. UP [▲] & DOWN [▼] BUTTONS

- Increase or decrease in the value of a setting respectively.

D. CONTROL BUTTONS - BACK PANEL

D1. BATTERY COMPARTMENT

- Accommodates four (4) pieces of UM-3 or "AA" size batteries

D2. [HISTORY] BUTTON

- Displays the barometric reading for the last 24 hours, or enter the altitude compensation setting

D3. [mb / hPa - inHg] SLIDE SWITCH

- Selects between "mb / hPa" or "inHg" pressure unit display

D4. [°C / °F] SLIDE SWITCH

- Selects between Centigrade (°C) or Fahrenheit (°F) temperature unit display

D5. [RESET] BUTTON

- Resets the unit by returning all setting to their default values

FEATURES : REMOTE THERMO-HYGRO SENSOR THGR228N

a. Two-line LCD

Displays the current temperature and humidity monitored by the remote unit

b. LED indicator

Flashes when the remote unit transmits a reading

c. °C/°F slide switch

Selects between Centigrade (°C) and Fahrenheit (°F)

d. Channel slide switch

Designates the remote unit Channel 1, Channel 2 or Channel 3

e. RESET

Returns all settings to default values

f. Battery compartment

Accommodates two (2) pieces of UM-4 or AAA-size batteries

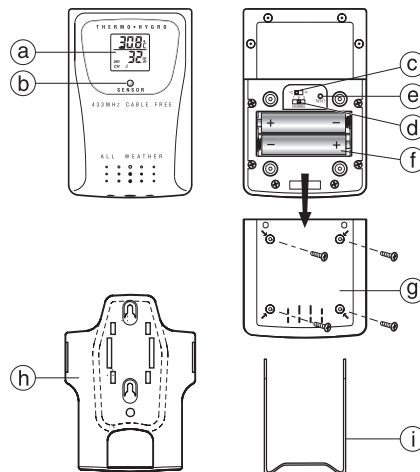
**g. Battery door****h. Wall-mount holder**

Supports the remote unit in wall-mounting

i. Removable table stand

For standing the remote unit on a flat surface

BEFORE YOU BEGIN - INSTALLING THE TABLE STAND

Before operation, plug the detachable table stand into the display unit as shown.

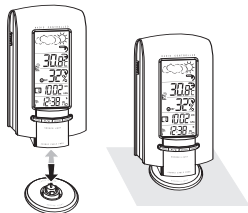

You can rotate the display unit freely by moving the unit around.

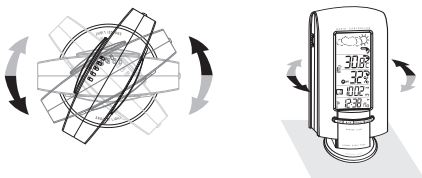

NOTES ON OPERATION

For best operation:

1. Insert batteries for the main unit first. Then proceed with inserting the batteries for the remote unit.

2. Position the remote unit and the main unit within effective transmission range. In usual circumstances, the effective range is up to 100 meters.
3. Though the remote unit is weather proof, it should be placed away from direct sunlight, rain or snow.

BATTERY INSTALLATION: MAIN UNIT

1. Gently open the battery compartment door as shown.

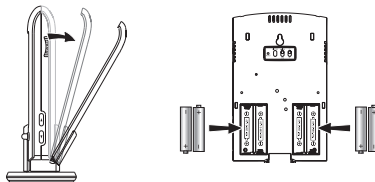

2. Insert four (4) pieces of UM-3 or "AA" size batteries in accordance with the polarities shown.
3. Close the battery compartment door.

BATTERY AND CHANNEL INSTALLATION: REMOTE UNIT

The remote thermo-hygro sensor unit uses two (2) UM-4 or "AAA" size batteries.

Follow these steps to install / replace batteries:

1. Remove the screws on the battery compartment.
2. Select the channel number on the **CHANNEL** slide switch.
3. Select the temperature display unit on the °C/°F slide switch.

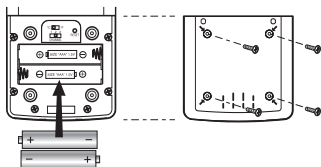

4. Insert the batteries strictly according to the polarities shown therein.
 5. Replace the battery compartment door and secure its screws.
- Replace the batteries when the low-battery indicator of the particular channel lights up on the main unit.

Note that once a channel is assigned to a remote unit, you can only change it by removing the batteries or resetting the unit.

LCD AND KEY-PANEL BACKLIGHT

For easy viewing in the dark this unit is featured with backlight function on the LCD display as well as on the front key-panel.

Also, this unit is specially designed so that the backlight can be operated differently no matter it is wall-mounted or being put on the table.

Wall-Mount

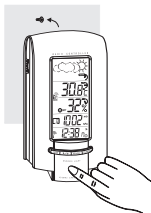
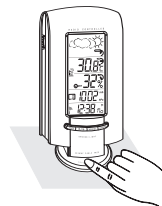

Table-Stand



Press the corresponding [**SNOOZE / LIGHT**] button or stand-button once. The backlight will be activated for 5 seconds.





ABOUT RADIO RECEPTION

BAR898HG is designed to automatically synchronize its calendar clock once it is brought within range of the Frankfurt DCF77 radio signal. When the unit is within range, its radio-control mechanism will override all manual settings unless auto-reception of radio signal has been manually deactivated.

When the unit is receiving radio signal, the radio reception icon will start to blink. A complete reception generally takes about 2 to 10 minutes, depending on the strength of the radio signal. When the reception is complete, the radio reception icon will stop blinking. The strength of the reception for the last full hour will be indicated.

For better reception, place the unit away from metal objects and electrical appliances to minimize interference.

Should you wish to deactivate the RF controlled function, press [**MODE**] and [**▼**] button simultaneously. The radio reception icon will disappear. To reactivate the RF controlled function, press [**MODE**] and [**▲**] simultaneously and the radio reception icon will be displayed again.

	STRONG		NO RECEPTION
	WEAK		RECEIVING

SETTING THE CLOCK AND CALENDAR MANUALLY

1. Press and hold [**MODE**] button for three seconds. The 12-hr value will flash. Use the [**▲**] or [**▼**] buttons to make a selection between 24-hour display or 12-hour display.
2. Press [**MODE**] button again, the hour will flash. Use the [**▲**] or [**▼**] button to enter the hours. Holding down either the up or down position will increase or decrease the value rapidly.
3. Press [**MODE**] button again to confirm. Repeat the above steps to set the minute, year, day/month or month/day display format, month, day and language for day-of-week respectively.
4. Press [**MODE**] button to confirm and exit the settings.
5. For the language for day-of-week, you can select E for English, D for German, F for French, I for Italian or S for Spanish. The day-of-week can be expressed as an abbreviation in five

different languages. The languages and their selected abbreviations for each day of the week are shown in the language chart below.





Language	Day-of-the-week						
	Monday	Tuesday	Wed.	Thursday	Friday	Saturday	Sunday
English	E	Mo	Tu	We	Th	Fr	Sa Su
German	D	Mo	Di	Mi	Do	Fr	Sa So
French	F	Lu	Ma	Me	Je	Ve	Sa Di
Italian	I	Lu	Ma	Me	Gi	Ve	Sa Do
Spanish	S	Lu	Ma	Mi	Ju	Vi	Sa Do

Note: When changes are made to the minute, the seconds will start from zero.



SETTING THE ALARM

To set the Alarm:

1. Press [**▶/✱**] button to display the daily alarm time (the icon "AL" will be displayed)
2. Press and hold [**▶/✱**] for three seconds and the value for the hour will flash.
3. Press [**▲**] or [**▼**] buttons to make changes to the alarm hour setting.

4. Press [ / *] and the minute will flash. Enter the value for the minute by using [] or [] buttons.
5. Press [ / *] to exit.

The alarm will be automatically activated. The **ALARM ON** icon [] is shown and the alarm will activate at the specified time.

To deactivate the daily alarm function, press the [] button when the alarm time is displayed. The **ALARM ON** icon will disappear and [- : - -] will be displayed. To activate, press the [] button to display the alarm time again.

ALARM AND SNOOZE FUNCTION

When the daily alarm goes off, the backlight will be on for five seconds and the alarm-on icon will flash.

Initially the active alarm will have a gentle sound. The intensity will increase in three stages. Without interruption, the unit will alarm for 2 minutes.

To stop the alarm sound, press any button (except [**MEMORY**] & [**CHANNEL**] buttons).

If the [**SNOOZE / LIGHT**] button or stand-button is pressed, the snooze function will be triggered. The alarm sound will stop and the alarm-on icon will blink for eight minutes. After that the alarm will go off again.







To deactivate the **SNOOZE** function, press the [ / *] button.

PRE-ALARM FUNCTION FOR CHANNEL 1 REMOTE SENSOR

The alarm function also has a pre-alarm feature which can alert the user before the preset alarm time when weather condition changes.

This pre-alarm function applies to Channel 1 Remote Sensor only.

To enable this function:

1. First activate the alarm function. Then enter the Pre-Alarm mode by pressing the [ / *] button twice. The "PRE-AL" icon will be displayed.
2. Press and hold the [ / *] button for 3 seconds to set the operating time interval for this pre-alarm function. Use the [] or [] button to select from the 4 time-intervals: 15, 30, 45 or 60 minutes.
3. Press the [ / *] button to confirm and exit. The pre-alarm function will be enabled automatically which is indicated by the appearance of the [*] symbol.
4. To disable this function, press the [] button in the Pre-Alarm mode. The [*] symbol will disappear and [- : - -] will appear to indicate disable of this function.

The pre-alarm will operate during the selected time interval before the daily alarm time.

During the pre-alarm operating period, if the temperature recorded at Channel 1 remote sensor falls to or below 2.0°C, the pre-alarm will be triggered. For example, if the daily alarm is set to go off at 7:00 am and the pre-alarm operating time interval is set to 45

minutes, the pre-alarm will start to operate at 6:15 am (45 minutes before 7:00 am). The Pre-Alarm icon will flash and the backlight will be turned on for 5 seconds. An alarm sound will also go off for 2 minutes as that of the daily alarm and the snooze function will also be activated if the [**SNOOZE / LIGHT**] button or stand-button is pressed.

Note: The daily alarm will NOT function until the next day if the pre-alarm has been triggered beforehand. Deactivation of the alarm function will disable the pre-alarm feature automatically.

NOTE ON REMOTE READINGS

Once batteries are in place in the remote unit, it will start transmitting samplings at 40-second intervals. If no signals are received when the remote sensor display is selected, "---" will be displayed. To force the main unit to search for remote sensor signals, press [**MEMORY**] and [**CHANNEL**] simultaneously.

If that fails, check that the remote sensor is still in place. Make sure the transmission is within range and the path is clear of obstacles and interference. Repeat this procedure whenever you find discrepancies between the display on the main unit and the display on the remote sensor.

CHECKING INDOOR AND REMOTE TEMPERATURES & HUMIDITIES

To display the indoor and outdoor temperature and humidity readings, press the [**CHANNEL**] button to toggle among the indoor, Channel 1, 2 and 3 displays.

The temperature can be shown in Centigrade ($^{\circ}\text{C}$) or Fahrenheit ($^{\circ}\text{F}$). Select the appropriate reading by using the [$^{\circ}\text{C} / ^{\circ}\text{F}$] slide switch (located in the battery compartment). Slide the switch to $^{\circ}\text{C}$ for Centigrade or $^{\circ}\text{F}$ for Fahrenheit.

If the reading goes above or below the specified amounts, the display will show a flashing "HHH" or "LLL".

This unit has an auto-scan function that can sequentially display the indoor and remote readings. To activate this function, press and hold the [**CHANNEL**] button for 3 seconds. To deactivate press the [**CHANNEL**] button again.

NOTE ON $^{\circ}\text{C}$ AND $^{\circ}\text{F}$

The outdoor temperature display on the main unit is dominated by the selection on the [$^{\circ}\text{C} / ^{\circ}\text{F}$] slide switch of the main unit. Whatever the display unit of the remote sensor is, it will only apply to the remote sensor itself and the temperature will be automatically converted to the chosen one of the main unit.

MAXIMUM AND MINIMUM TEMPERATURES & HUMIDITIES



The maximum and minimum recorded temperatures and humidities will be automatically stored in memory. To display them, press [**MEMORY**]. Press [**MEMORY**] again to alternate between the maximum, minimum and current readings. The respective **MAX** or **MIN** indicator will be displayed.



To clear the memory, press [**MEMORY**] and hold for three seconds. The maximum and minimum recorded readings will be

erased. Subsequently, if you press [MEMORY] after the memory has been erased, the maximum and minimum readings will have the same values as the current ones.

TEMPERATURE & HUMIDITY TREND



The temperature and humidity trend indicator shows the trend of temperatures and humidities collected at that particular sensor. Three trends: rising, steady, and falling will be shown.

Arrow indicator			
Temperature Trend	Rising	Steady	Falling

Arrow indicator			
Humidity Trend	Rising	Steady	Falling





ATMOSPHERIC PRESSURE

The atmospheric pressure arrow indicator will indicate if the atmospheric pressure is increasing, remaining stable, or decreasing.

Arrow indicator			
Pressure Trend	Rising	Steady	Falling

WEATHER FORECAST

The unit is capable of detecting atmospheric pressure changes. Based on collected data, it can predict the weather for the forthcoming 12 to 24 hours. The effective range covers an area of 30 to 50 km.

				
Sunny	Partly cloudy	Cloudy	Rainy	Snow



NOTE:

1. The accuracy of a general pressure-based weather forecast is about 70% to 75%.
2. The weather forecasts from this unit are predictions that cover the next 12 to 24 hours. It may not necessarily reflect the current situation.
3. The "Sunny" icon, as applies to night time, implies clear weather.

COMFORT LEVEL INDICATORS

The comfort level indicators COM, WET or DRY will tell you if the current environment is comfortable, too wet or too dry.

The comfort indicator will appear on the display when the following conditions are satisfied:

Indicator displays on the unit	Temperature Range	Humidity Range	Shows that the Current Environment
 COM	20°C to 25°C (68°F to 77°F)	40%RH- 70%RH	Ideal range for both relative humidity and temperature
 WET	-5°C + 50°C (23°F - 122°F)	OVER- 70%RH	Contains excess moisture
 DRY	-5°C + 50°C (23°F - 122°F)	Below 40%RH	Contains inadequate moisture
No Indicator	Less than 20°C (68°F) or More than 25°C (77°F)	40%RH to 70%RH	No comment

HOW TO CHECK THE BAROMETRIC PRESSURE

The current and historical barometric pressure is shown on the atmospheric pressure window.

For monitoring the local barometric pressure reading, "0" meter (preset value) should be selected for the altitude setting. For monitoring the Sea Level barometric pressure reading at certain altitude, the local altitude should be selected as the altitude setting. To set the altitude, press and hold [**HISTORY**] button to enter the altitude compensation setting mode. Use the [**▲**] or [**▼**] button to select from -100 to 2500 meters (whichever appropriate). Press [**HISTORY**] button to confirm and exit.

The atmospheric pressure can be displayed in mb/hPa or inHg. The pressure unit is selected on the atmospheric pressure slide switch inside the battery compartment.

If you want to check the pressure history for a particular hour during the past 24 hours, press the [**HISTORY**] button. Each press on the button will go back by an hour. Holding down the button will increase the value rapidly.

LOW BATTERY INDICATION

When it is time to replace batteries, the respective low battery indicator [**⚡**] will show up when the corresponding channel is selected. The battery level of the main unit is shown on the Weather Forecast Window when it is running low.

HOW TO WALL MOUNT OR USE THE TABLE STAND (REMOTE UNIT)

As for the remote unit, it comes with a wall-mount holder and a removable stand. Use either to hold the unit in place.

Wall-Mount:



Table-Stand:

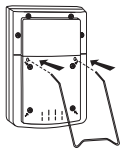

HOW TO WALL MOUNT OR USE THE TABLE STAND (MAIN UNIT)

The unit can be wall-mounted using its recessed screw holes or placed on a flat surface using the detachable table stand.

Wall-Mount:



Table-Stand:

Gently plug in the table stand as shown:

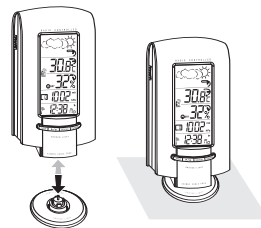

HOW TO RESET THE UNIT

The [**RESET**] button allows you to return all settings to factory values. Accessing the slot is required only when the unit is not operating in a favorable way such as in the rare case of a malfunction.

The [**RESET**] slot is located inside the battery compartment door. To use the button:

1. Open the battery compartment door.
2. Place a blunt stylus into the hole and press.
3. Close the battery compartment door.

Remote sensing unit : uses two (2) UM-4 or "AAA" 1.5V batteries

Weight

Main unit : 300gm (without battery)

Remote sensing unit : 63gm (without battery)

Dimensions

Main unit : 195 (L) x 105 (W) x 77 (T) mm

Remote sensing unit : 92 (L) x 60 (W) x 20 (T) mm

CAUTION

- The content of this manual is subject to change without further notice.
- The technical specifications of this product are subject to change without notice.
- Due to printing limitation, the displays shown in this manual may differ from the actual display.
- The contents of this manual may not be reproduced without the permission of the manufacturer.

EC-DECLARATION OF CONFORMITY

This product contains the approved transmitter module **TX 01** and complies with the essential requirements of Article 3 of the R&TTE 1999/5/EC

Directives, if used for its intended use and that the following standard(s) have been applied:

Efficient use of radio frequency spectrum

(Article 3.2 of the R&TTE Directive)

applied standard(s)

EN 300 220-1(2,3):1997

Electromagnetic compatibility

(Article 3.1.b of the R&TTE Directive)

applied standard(s)

ETS 300 683:1997

Safety of information technology equipment

(Article 3.1.a of the R&TTE directive)

applied standard(s)

EN 60950:1997

Additional information:

The product is therefore conform with the Low Voltage Directive 73/23/EC, the EMC Directive 89/336/EC and R&TTE Directive 1999/5/EC (appendix II) and carries the respective CE marking.

VS-Villingen / Germany August 2001

Gerhard Preis

R&TTE Representative of manufacturer

CE 0682 

RTTE Compliant Countries :

All EC countries, Switzerland 

And Norway 