

Wireless Weather Station with World Time Clock

Model: BAR916HG

USER MANUAL

CONTENTS

Introduction	3
Product Overview	4
Front View	4
Back View	5
Table Stand and Wall Mount.....	5
LCD Display	6
Remote Sensor (RTGR328N)	9
Getting Started	9
Batteries	9
Change Settings.....	10
Remote Sensor	10
Set Up Thermo / Hygro Sensor (RTGR328N).....	11
Sensor Data Transmission	12
Search for Sensor	12
Clock and Calendar	12
Radio-Controlled Clock	12
Turn Radio-Controlled Clock ON / OFF	13
Set Clock.....	14
Switch Clock Display	14

WorldTimeClock.....	14
Alarms	19
Set Daily Alarm.....	19
Set Pre-Alarm.....	19
Activate Alarm	20
Snooze	20
Barometer	20
View Barometer Area	20
Select Measurement Unit.....	20
View Barometer History	20
Bar Chart Display	21
Set Altitude	21
Weather Forecast	21
Weather Forecast Icons	21
UV Measurement	22
New Additional UV Features	22
Temperature and Humidity	23
View Temperature and Humidity Area	24
Select Measurement Unit.....	24
Select Sensor Channel	24
Minimum / Maximum Records.....	24
Temperature and Humidity Trend.....	24
Comfort Zone	25
Heat Index.....	25
Backlight	25

Reset System	25
Safety and Care	26
Warnings	26
Troubleshooting	26
Specifications	27
About Oregon Scientific	28
EU-Declaration of Conformity	29



INTRODUCTION

Thank you for selecting the Oregon Scientific™ Wireless Weather Station with World Time Clock (BAR916HG). This powerful device bundles time keeping, weather monitoring, indoor and outdoor temperature and humidity readings, barometric trends and altitude adjustment, into a single tool you can use from the convenience of your home.

In this box, you will find:

- Main unit
- Remote sensor (RTGR328N)
- Optional UV sensor (UVR128)
- Batteries

BAR916HG --- BAR916HG Main Unit + RTGR328N Remote Sensor

NOTE The main unit is compatible with the following sensors: THGR228N, THGR328N, THR228N, THR328N, THWR288. Additional sensors are sold separately. Please contact your local retailer for more information. Keep this manual handy as you use your new product. It contains practical step-by-step instructions, as well as technical specifications and warnings you should know.

PRODUCT OVERVIEW

FRONT VIEW

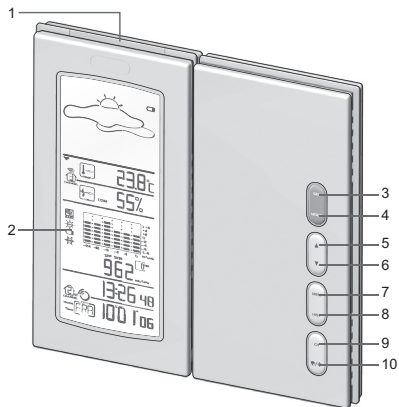

1. **SNOOZE / LIGHT:** Activate 8-minute snooze or backlight
2. LCD display
3. **SEL:** Switch areas
4. **MODE:** Change settings / display
5. ▲: Increase setting / activate radio-controlled clock
6. ▼: Decrease setting / deactivate radio-controlled clock
7. **MEM:** View current, maximum and minimum temperature / humidity / UV readings
8. **HIST:** View historical barometer and UV readings
9. **CH:** Switch remote sensor display
10. 📡 / * : View alarm status; set alarm radio-controlled clock

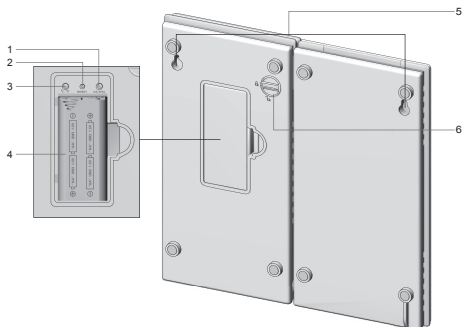
**BACK VIEW**

1. **mb / inHg** switch (in battery compartment)
2. **RESET** button (in battery compartment)
3. **°C / °F** switch (in battery compartment)
4. Battery compartment (cover open)
5. Wall mount holes
6. Lock button -place the 2 parts of the unit next to each other, as shown opposite. Twist the lock button to secure the 2 unit parts together. Twist it anti-clockwise to release the lock and separate the two segments.

TABLE STAND AND WALL MOUNT

To stand the unit on a table, twist the lock button (on the back of the unit) so that the two main unit segments are unlocked from each other. Then position the unit as shown below.

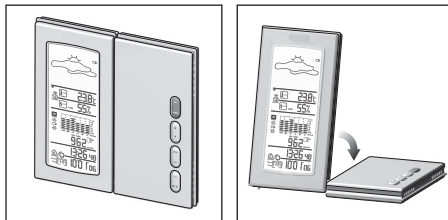

To mount the unit on a wall, twist the lock button (on the back of the unit) so that it locks the two segments together. Then mount as shown below.

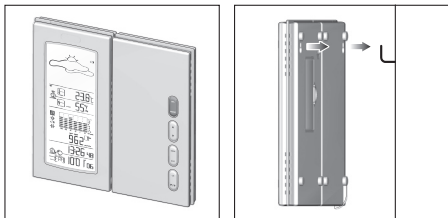

LCD DISPLAY

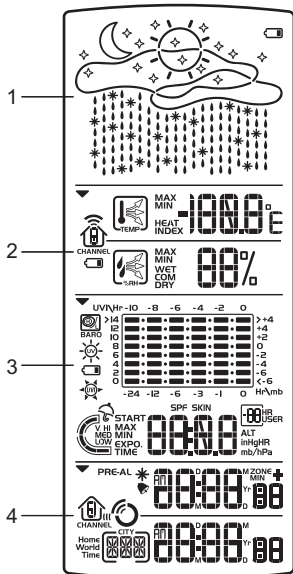

- Weather Forecast Area:** Animated weather forecast.
- Temperature / Humidity / Comfort Zone Area:** Readings and trend lines; comfort zone; sensor channel number.
- UVI / Barometer Area:** UV level and barometric pressure bar chart; UV Index and barometric readings.
- Clock / Alarm / Calendar Area:** Radio-controlled clock with World time; alarms; calendar.



Weather Forecast Area

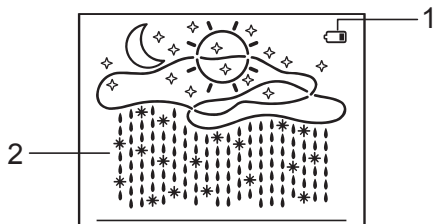

1. Low battery icon for main unit
2. Weather display

Temperature / Humidity / Comfort Zone Area

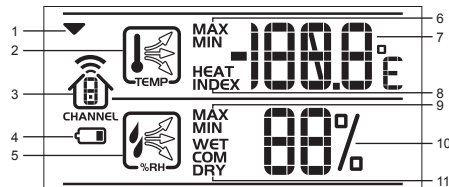

1. Selected Area icon
2. Temperature trend
3. Channel number (1-5) / reception status
4. Low battery icon for remote sensor
5. Humidity trend
6. MAX / MIN temperature
7. Temperature - °C / °F
8. Heat Index
9. MAX / MIN humidity
10. Humidity
11. Comfort levels

UVI / Barometer Area

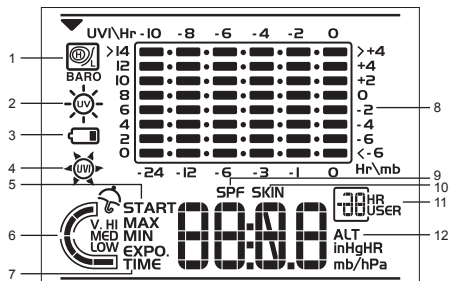

1. Barometric pressure is showing
2. UV is showing
3. Low battery icon for UV sensor
4. UVI value is showing
5. UV exposure time countdown has started
6. UV index level
7. UV exposure time for user
8. Barometer / UV chart
9. SPF applied to user for UV exposure
10. User skin type for UV exposure
11. User no. (for UV Mode) or hour history for UV / Barometric pressure reading
12. Altitude / barometric pressure / UVI reading

Clock / Alarm / Calendar Area

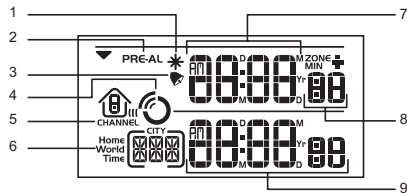

1. Pre-Alarm is set
2. Pre-Alarm display / Pre-Alarm setting
3. Channel with RF clock reception is locked
4. RF clock reception icon
5. Daily Alarm is set
6. Home or World time city
7. RF clock time (i.e. home clock time) / calendar
8. Offset time-zone
9. World clock time / calendar

REMOTE SENSOR (RTGR328N)

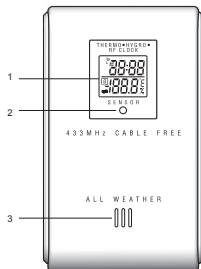

1. LCD display
2. LED status indicator
3. Ventilation duct

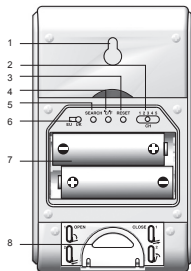

1. Wall mount
2. **CHANNEL** switch (1-5)
3. **RESET**
4. **°C / °F**
5. **SEARCH**
6. **EU / UK** radio signal format switch
7. Battery compartment
8. Fold-out stand

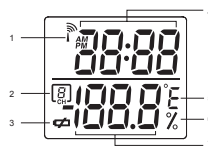

1. Signal reception
2. Channel number
3. Low battery icon
4. Time
5. Temp (°C or °F)
6. Humidity %
7. Temp / Humidity

GETTING STARTED

BATTERIES

Batteries are supplied with this product:

- Main unit 4 x UM-3 (AA) 1.5V
- Remote unit 2 x UM-3 (AA) 1.5V

Insert batteries before first use, matching the polarity as shown in the battery compartment. For best results, install batteries in the remote sensor before the main unit. Press **RESET** after each battery change.

To install the main unit batteries:

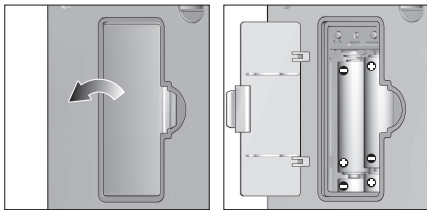

NOTE Do not use rechargeable batteries.

 shows when batteries are low.





NOTE It is recommended that you use alkaline batteries with this product for longer performance.

UNIT	 LOCATION
Main	Weather Forecast Area
Remote	Temperature / Humidity Area
UV Sensor	UVI / Barometric Pressure Area

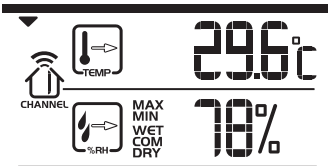
CHANGE SETTINGS

1. Press **SEL** to switch between Areas. ▼ indicates the selected Area.



2. Most Areas have alternate display options (for example, Clock / Alarm or Barometer / UVI). Press **MODE** to switch options, or  /  to switch between clock and alarm.
3. Press and hold **MODE** for 2 seconds to enter setting mode.
4. Press  or  to change settings.
5. Press **MODE** to confirm.

REMOTE SENSOR

This product is shipped with the RTGR328N Thermo / Hygro Sensor. The main unit can collect data from up to 6 sensors (5 Thermo / Hygro Sensors and 1 UV Sensor).

The main unit is compatible with the following sensors: THGR228N, THGR328N, THR228N, THR328N and THWR288. (Additional sensors are sold separately. Contact your local retailer for more information.)

The RTGR328N Sensor collects temperature and humidity readings, and signals from official time-keeping organizations for the radio-controlled clock.

SET UP THERMO / HYGRO SENSOR (RTGR328N)

1. Open the battery compartment with a small Phillips screwdriver.
2. Insert the batteries.
3. Set the channel and radio signal format. The switches are located in the battery compartment.

SWITCH	OPTION
Channel	If you are using more than one sensor, select a different channel for each sensor
Radio Signal Format	EU (DCF) / UK (MSF)

4. Press **RESET**. Then set the temperature unit.

SWITCH	OPTION
Temp	°C / °F

5. Close the battery compartment.

To fold out the stand:

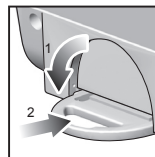

For best results:



- Insert the batteries and select the unit, channel, and radio signal format before you mount the sensor.
- Place the sensor out of direct sunlight and moisture.
- Do not place the sensor more than 70 metres (230 feet) from the main (indoor) unit.
- Position the sensor so that it faces the main (indoor) unit, minimizing obstructions such as doors, walls, and furniture.
- Place the sensor in a location with a clear view to the sky, away from metallic or electronic objects.
- Position the sensor close to the main unit during cold winter months as below-freezing temperatures may affect battery performance and signal transmission.

NOTE The transmission range may vary and is subject to the receiving range of the main unit.

You may need to experiment with various locations to get the best results.

SENSOR DATA TRANSMISSION

Data is sent from the sensor(s) every 60 seconds. The reception icon shown in the Temperature / Humidity Area indicates the status.

ICON	DESCRIPTION
	Main unit is searching for sensors.
	At least 1 channel has been found.
	Sensor 1 is sending data. (The number shows which sensor is selected.)
--- shows in Temp / Humidity Area	The selected sensor cannot be found. Search for the sensor or check batteries.

SEARCH FOR SENSOR

To search for a Thermo / Hygro sensor, press **SEL** to navigate to the Temperature / Humidity Area. ▼ will show next to the Area. Then, simultaneously press and hold **MEM** and **CH** for 2 seconds.

To search for the UV sensor, press **SEL** to navigate to the UVI / Barometer Area. ▼ will show next to the Area.

Then, press and hold **MEM** and **CH** for 2 seconds.

NOTE If the sensor is still not found, check the batteries.

CLOCK AND CALENDAR

This product tracks the time and date based on radio-controlled signals from the RTGR328N remote sensor, or manual settings that you enter.

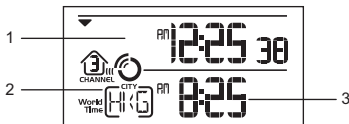

1. RF Clock time
2. World Time city
3. World Time clock

RADIO-CONTROLLED CLOCK



The time and date are automatically updated by radio-controlled clock signals from official time-keeping organizations in Frankfurt (Germany) and Rugby (England) unless you disable this feature. The signals are collected by the remote sensor (RTGR328N) whenever it is within 1500 km (932 miles) of a signal.

Initial reception takes 2-10 minutes, and is initiated when





you first set up the unit, and whenever you press **RESET**. Once complete, the reception icon will stop blinking.

In addition to the local time and calendar display, you can also select to display the corresponding time of 130 major world cities.

The  icon shown in the Clock Area indicates 2 factors:

- Connection between the main unit and the sensor that collects RF signals ()
- RF signal reception ()

How these signals work together:



ICON	MEANING
	The unit has contact with the sensor and has synchronized the time.
	The unit has contact with the sensor but the time has not been synchronized.
	The unit has lost contact with the remote sensor but the time is synchronized.
	The unit has lost contact with the remote sensor and the time is not synchronized.



The unit cannot reach the remote sensor.

NOTE To force a manual search for RF clock reception, press and hold **SEARCH** on the sensor (RTGR328N) for 2 seconds.

TURN RADIO-CONTROLLED CLOCK ON / OFF

If you wish to manually set the clock, you must first disable the radio-controlled feature. To do this, navigate to the Clock / Alarm Area. Then, press and hold  on the main unit for 2 seconds. To enable it, navigate to the Clock / Alarm Area, then press and hold  for 2 seconds.

RF clock enabled:



RF clock disabled:



SET CLOCK

You only need to do this if you have disabled the radio-controlled clock, or if you are too far from a RF signal.

1. Press **SEL** to navigate to the Clock Area. ▼ will show next to the Area.
2. Press and hold **MODE** for 2 seconds.
3. Select the Home Time city, World Time city, 12 / 24 hour format, hour, minute, year, date / month format, month, date and display language.
4. Press ▲ or ▼ to change the setting.
5. Press **MODE** to confirm.

NOTE The language options are (E) English, (F) French, (D) German, (I) Italian, and (S) Spanish. The language you select determines the weekday display.

SWITCH CLOCK DISPLAY

Press **SEL** to navigate to the Clock Area. ▼ will show next to the Area.

Press **MODE** to toggle between different displays.

When the World Time city is not set, you can toggle between:

- Clock with seconds and date

- Clock with day and date

When the World Time city is set, you can toggle between:

- RF clock with seconds and World Time clock
- RF and World Time clock with day
- RF and World Time date

WORLD TIME CLOCK

This clock features a World-time display function so that you check the corresponding time of different places in the world instantly with Daylight Saving Time (DST) automatically adjusted. The names of the world cities are in the abbreviated 3-letter format e.g., FRA for Frankfurt, Germany.



CITY, COUNTRY	CITY CODE	TIME OFFSET	SUMMER TIME START DATE	SUMMER TIME END DATE
Addis Ababa, Ethiopia	ADD	3	No DST	
Adelaide, Australia	ADL	9.5	Last Sunday in October	Last Sunday in March
Auckland, New Zealand	AKL	12	1st Sunday in October	3rd Sunday in March
Ankara, Turkey	AKR	2	Last Sunday in March	Last Sunday in October
Algiers, Algeria	ALG	1	No DST	
Amsterdam, Netherlands	AMS	1	Last Sunday in March	Last Sunday in October
Anchorage AK, USA	ANC	-9	1st Sunday in April	Last Sunday in October
Antananarivo, Madagascar	ANT	3	No DST	
Asuncion, Paraguay	ASU	-4	1st Sunday in September	1st Sunday in April
Athens, Greece	ATH	2	Last Sunday in March	Last Sunday in October
Atlanta GA, USA	ATL	-5	1st Sunday in April	Last Sunday in October
Abu Dhabi, U.A.E	AUH	4	No DST	
Bucharest, Romania	BBU	2	Last Sunday in March	Last Sunday in October
Barcelona, Spain	BCN	1	Last Sunday in March	Last Sunday in October
Baghdad, Iraq	BDD	3	1st April	1st October
Belgrade, Yugoslavia	BEG	1	Last Sunday in March	Last Sunday in October
Beijing, China	BEJ	8	No DST	
Berlin, Germany	BER	1	Last Sunday in March	Last Sunday in October
Beirut, Lebanon	BEY	2	Last Sunday in March	Last Sunday in October
Bangkok, Thailand	BKK	7	No DST	
Brisbane, Australia	BNE	10	No DST	
Bogota, Colombia	BOG	-5	No DST	
Boston MA, USA	BOS	-5	1st Sunday in April	Last Sunday in October
Bern, Switzerland	BRN	1	Last Sunday in March	Last Sunday in October
Brussels, Belgium	BRU	1	Last Sunday in March	Last Sunday in October
Brasilia, Brazil	BSB	-3	2nd Sunday in October	3rd Sunday in February
Buenos Aires, Argentina	BUA	-3	No DST	
Budapest, Hungary	BUD	1	Last Sunday in March	Last Sunday in October
Cairo, Egypt	CAI	2	last Friday in April	Last Friday in September
Casablanca, Morocco	CAS	0	No DST	
Canberra, Australia	CBR	10	Last Sunday in October	Last Sunday in March
Caracas, Venezuela	CCS	-4	No DST	
Calcutta, India	CCU	5.5	No DST	
Chicago IL, USA	CGX	-6	1st Sunday in April	Last Sunday in October
Colombo, Sri Lanka	CMB	6	No DST	
Copenhagen, Denmark	CPH	1	Last Sunday in March	Last Sunday in October

Cape Town, South Africa	CPT	2	No DST	
Dhaka, Bangladesh	DAC	6	No DST	
Damascus, Syria	DAM	2	1st April	1st October
New Delhi, India	DEL	5.5	No DST	
Detroit MI, USA	DTW	-5	1st Sunday in April	Last Sunday in October
Dublin, Ireland	DUB	0	Last Sunday in March	Last Sunday in October
Frankfurt, Germany	FRA	1	Last Sunday in March	Last Sunday in October
Guatemala City, Guatemala	GUA	-6	No DST	
Geneva, Switzerland	GVA	1	Last Sunday in March	Last Sunday in October
Hamburg, Germany	HAM	1	Last Sunday in March	Last Sunday in October
Hanoi, Vietnam	HAN	7	No DST	
Havana, Cuba	HAV	-5	1st Sunday in April	Last Sunday in October
Ho Chi Minh City, Vietnam	HCM	7	No DST	
Helsinki, Finland	HEL	2	Last Sunday in March	Last Sunday in October
Hong Kong, China	HKG	8	No DST	
Honolulu HI, USA	HNL	-10	No DST	
Houston TX, USA	HOU	-6	1st Sunday in April	Last Sunday in October
Indianapolis, IN, USA	IND	-5	No DST	
Istanbul, Turkey	IST	2	Last Sunday in March	Last Sunday in October
Jakarta, Indonesia	JKT	7	No DST	
Johannesburg, South Africa	JNB	2	No DST	
Kabul, Afghanistan	KBL	4.5	No DST	
Khartoum, Sudan	KHA	3	No DST	
Kiev, Ukraine	KIE	2	Last Sunday in March	Last Sunday in October
Kingston, Jamaica	KIN	-5	No DST	
Kathmandu, Nepal	KTM	5.75	No DST	
Kuala Lumpur, Malaysia	KUL	8	No DST	
Kuwait City, Kuwait	KWI	3	No DST	
Las Vegas NV, USA	LAS	-8	1st Sunday in April	Last Sunday in October
Los Angeles CA, USA	LAX	-8	1st Sunday in April	Last Sunday in October
Lima, Peru	LIM	-5	No DST	
Lisbon, Portugal	LIS	0	Last Sunday in March	Last Sunday in October
London, UK	LON	0	Last Sunday in March	Last Sunday in October
Lagos, Nigeria	LOS	1	No DST	
La Paz, Bolivia	LPB	-4	No DST	
Luxembourg, Luxembourg	LUX	1	Last Sunday in March	Last Sunday in October
Madrid, Spain	MAD	1	Last Sunday in March	Last Sunday in October



Melbourne, Australia	MEL	10	Last Sunday in October	Last Sunday in March
Mexico City, Mexico	MEX	-6	1st Sunday in April	Last Sunday in October
Managua, Nicaragua	MGA	-6	No DST	
Miami FL, USA	MIA	-5	1st Sunday in April	Last Sunday in October
Milan, Italy	MIL	1	Last Sunday in March	Last Sunday in October
Manama, Bahrain	MNA	3	No DST	
Manila, Philippines	MNL	8	No DST	
Montreal, Canada	MON	-5	1st Sunday in April	Last Sunday in October
Moscow, Russia	MOW	3	Last Sunday in March	Last Sunday in October
Montevideo, Uruguay	MVD	-3	No DST	
Nassau, Bahamas	NAS	-5	1st Sunday in April	Last Sunday in October
Nairobi, Kenya	NRB	3	No DST	
New York NY, USA	NYC	-5	1st Sunday in April	Last Sunday in October
Oslo, Norway	OSL	1	Last Sunday in March	Last Sunday in October
Ottawa, Canada	OTW	-5	1st Sunday in April	Last Sunday in October
Port-au-Prince, Haiti	PAP	-5	No DST	
Paris, France	PAR	1	Last Sunday in March	Last Sunday in October
Perth, Australia	PER	8	No DST	
Phoenix, AZ, USA	PHE	-7	No DST	
Phnom Penh, Cambodia	PNH	7	No DST	
Port-Of-Spain, Trinidad & Tobago	POS	-4	No DST	
Papeete, French Polynesia	PPT	-10	No DST	
Prague, Czech Republic	PRG	1	Last Sunday in March	Last Sunday in October
Portland OR, USA	PTL	-8	1st Sunday in April	Last Sunday in October
Pretoria, South Africa	PTR	2	No DST	
Panama City, Panama	PTY	-5	No DST	
Rangoon, Myanmar	RGN	6.5	No DST	
Rio de Janeiro, Brazil	RIO	-3	2nd Sunday in October	3rd Sunday in February
Reykjavik, Iceland	RKV	0	No DST	
Rome, Italy	ROM	1	Last Sunday in March	Last Sunday in October
Riyadh, Saudi Arabia	RUH	3	No DST	
San Salvador, El Salvador	SAL	-6	No DST	
Santiago, Chile	SCL	-4	1st Sunday after 8th October	1st Sunday after 8th March
Seattle WA, USA	SEA	-8	1st Sunday in April	Last Sunday in October
Seoul, South Korea	SEL	9	No DST	
San Francisco CA, USA	SFO	-8	1st Sunday in April	Last Sunday in October
Shanghai, China	SHA	8	No DST	







Singapore, Singapore	SIN	8	No DST	
San Jose, Costa Rica	SJO	-6	No DST	
San Juan, Puerto Rico	SJU	-4	No DST	
Salt Lake City UT, USA	SLC	-7	1st Sunday in April	Last Sunday in October
Sofia, Bulgaria	SOF	2	Last Sunday in March	Last Sunday in October
Sao Paulo, Brazil	SPL	-3	2nd Sunday in October	3rd Sunday in February
Stockholm, Sweden	STH	1	Last Sunday in March	Last Sunday in October
Sydney, Australia	SYD	10	Last Sunday in October	Last Sunday in March
Tashkent, Uzbekistan	TAS	5	No DST	
Tokyo, Japan	TKY	9	No DST	
Taipei, Taiwan	TPE	8	No DST	
Tripoli, Libya	TRP	2	No DST	
Toronto, Canada	TRT	-5	1st Sunday in April	Last Sunday in October
Quito, Ecuador	UIO	-5	No DST	
Vancouver, Canada	VAC	-8	1st Sunday in April	Last Sunday in October
Vienna, Austria	VIE	1	Last Sunday in March	Last Sunday in October
Warsaw, Poland	WAW	1	Last Sunday in March	Last Sunday in October
Washington DC, USA	WDC	-5	1st Sunday in April	Last Sunday in October
Wellington, New Zealand	WLG	12	1st Sunday in October	3rd Sunday in March
Zurich, Switzerland	ZRH	1	Last Sunday in March	Last Sunday in October



ALARMS

This product has 2 alarms: The Daily Alarm and a Pre-Alarm for snowy weather. The Daily Alarm can be set to go off at the same time every day. The Pre-Alarm sounds only when the Daily Alarm is activated and the recorded temperature from Channel 1 Sensor falls to 2°C (35.6°F) or below.







SET DAILY ALARM

1. Press **SEL** to navigate to the Clock Area. ▼ will show next to the Area.
2. Press  /  to view the alarm. (AL will show at the top.)
3. Press and hold  /  for 2 seconds.
4. Select the hour and minute. Press ▲ or ▼ to change settings.
5. Press  /  to confirm.
6. The Daily Alarm icon will appear when the alarm is set.

SET PRE-ALARM

The Pre-Alarm can be set to sound 15, 30, 45, or 60 minutes before the Daily Alarm. It will sound whenever the recorded temperature from Channel 1 Sensor falls to 2°C (35.6°F) or below.

For example, if you set the alarm to 7:00 AM, and the Pre-Alarm to 45 minutes, the Pre-Alarm will sound at 6:15 AM provided the outdoor temperature at Channel 1 Sensor is 2°C or below.

1. Set up and activate the Daily Alarm.
2. Press  /  to switch to Pre-Alarm view. (PRE-AL will show at the top.)
3. Press and hold  /  for 2 seconds.
4. Press ▲ or ▼ to select 15, 30, 45 or 60 minutes. This is the amount of time the Pre-Alarm will sound BEFORE the Daily Alarm. The Pre-Alarm is automatically activated when you select a time.
5. Press  /  to confirm.

 shows when the Pre-Alarm is set.



NOTE The Daily Alarm will NOT function until the next day if the Pre-Alarm has been triggered. Also, if you deactivate the Daily Alarm, the Pre-Alarm is automatically deactivated.

ACTIVATE ALARM

Navigate to the Clock Area, then press  /  to switch to Daily Alarm or Pre-Alarm view. To activate or deactivate the alarm, press  or .

When the alarm time is reached, the backlight will be on for 8 seconds and crescendo alarm will sound for 2 minutes. Press any key (except snooze) to silence the alarm. It will sound at the same time the next day.

SNOOZE

Press **SNOOZE / LIGHT** to temporarily disable the alarm for 8 minutes.  or  will blink while snooze is on.

BAROMETER

This product tracks fluctuations in barometric pressure to provide the weather forecast, and the current and past 24 hours barometric pressure history measurements are recorded by the main (indoor) unit.

VIEW BAROMETER AREA

Press **SEL** to navigate to the Barometer Area.

If  is NOT shown, press **MODE**.

Barometric data is shown in 2 areas at the bottom of the display. The upper area shows a 24-hour bar chart. The lower area shows current and historical readings.

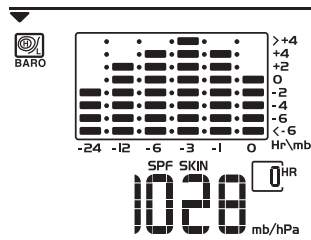

SELECT MEASUREMENT UNIT

Slide the **mb / inHg** switch (in the clock battery compartment), to change the display unit.

VIEW BAROMETER HISTORY

Navigate to the Barometer Area. Then press **HIST** repeatedly to scroll through the measurements. The number shown in the HR box indicates how long ago each measurement was taken (e.g. 2 hours ago, 3 hours ago, etc.).

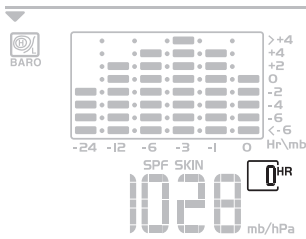

BAR CHART DISPLAY

The bar chart visually shows atmospheric changes from the current hour (0) to 24 hours prior (-24).

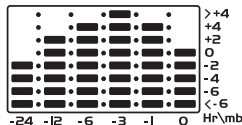

SET ALTITUDE

Set the altitude to match how far above or below sea level you are living. This ensures that the barometric pressure readings are accurate.

1. Navigate to the Barometer Area.
2. Press and hold **HIST** for 2 seconds.
3. Press ▲ or ▼ to set the altitude in 10-metre increments (-100m to 2500m).
4. Press **HIST** to confirm.

WEATHER FORECAST





This product forecasts the next 12 to 24 hours of weather within a 30-50 km (19-31 mile) radius. The forecast is based on barometric pressure trend readings.



The top area shows an animated icon indicating the forecasted weather.

WEATHER FORECAST ICONS

DESCRIPTION	ICON
Clear (Day)	
Partly Cloudy (Day)	

Cloudy	
Clear (Night)	
Partly Cloudy (Night)	
Snowy	
Rainy	

NOTE The night time icon displays from 6 PM to 6 AM. When the Channel 1 sensor records a temperature of 2°C (35.6°F) or lower, the RAINY icon becomes SNOWY.

UV MEASUREMENT

The UVR128 Ultra-Violet Radiation Sensor is included with the BAR966HG and is available as an optional item for the BAR916HG. The UV sensor gives you the following information at your fingertips:

- 10-hour Ultra-Violet Index (UVI) record.

- Automatic calculation of acceptable UV exposure times based on pre-set user profiles (4 users maximum).
- UVI Danger Alert when UV Index reaches unsafe levels.

UV data is shown in the same area as the Barometer. Press **SEL** to navigate to the Barometer Area, then press **MODE** to display the UV icon  and data.

NOTE Refer to the UVR128 User Manual for more information and see below to learn about the new additional UV features.

NEW ADDITIONAL UV FEATURES

UV EXPOSURE TIME COUNTDOWN

To set the exposure time countdown you need to set the Skin Type and Sun Protection Factor (SPF) as follows:

1. Press **SEL** to navigate to the Barometer Area, then press **MODE** to select the UV display.

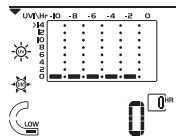

- Press **CH** to select user 1-4.
- Press and hold **MODE** for 2 seconds to enter the Skin Type Setting Mode of the selected user.

SKIN TYPE	TAN	BURN	HAIR COLOUR	EYE COLOUR
1	Never	Always	Red	Blue
2	Sometimes	Always	Blonde	Blue / Green
3	Always	Rarely	Brown	Grey / Brown
4	Always	Never	Black	Brown

- Press ▲ or ▼ to choose 1 of the 4 skin type settings. Then press **MODE** to confirm and enter the SPF Set Up Mode.

SPF	LEVEL OF PROTECTION
1 - 11	Low
12 - 29	Medium
30 - 50	High

- Press ▲ or ▼ to increase or decrease the SPF value. Then press **MODE** to confirm and enter the UV Exposure Time Countdown Setting Mode.
- Press ▲ or ▼ to enable or disable countdown. Press **MODE** to exit the UV Exposure Time Countdown Mode and start the exposure time

countdown. The remaining user UV exposure time will display and the **START** will flash.

- When the countdown has reached "0", an alarm will sound for 2 minutes. Press any button to turn the alarm off. The **EXPO TIME** icon will flash for 2 minutes even if you have stopped the alarm sound.

MAXIMUM / MINIMUM MEMORY FOR UVI

To view the maximum and minimum memory for UVI:

- Press **SEL** to navigate to the Barometer Area.
- Press **MODE** to select the UV display.
- Press **MEM** to show maximum, minimum and current UVI readings.
- Press and hold **MEM** for 2 seconds to clear the UVI memory.

NOTE The UV sensor must be activated before you try and set the additional features. Please refer to the UVR128 User Manual for more information.

TEMPERATURE AND HUMIDITY

The weather station can display the following information from any of the 5 remote sensors:

- Current, minimum, and maximum temperatures and relative humidity percentages.
- Comfort level indicator and trend line (rising, falling, or steady).

Data is collected and displayed approximately every 60 seconds.

VIEW TEMPERATURE AND HUMIDITY AREA

Press **SEL** to navigate to the Temperature and Humidity Areas.

Temperature data is given at the top; Humidity is below.

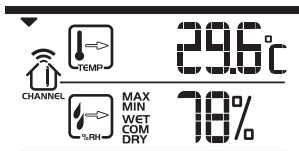

SELECT MEASUREMENT UNIT

Slide the °C / °F switch (inside the clock battery compartment), to the setting you want.

SELECT SENSOR CHANNEL

Press **CH** to switch between sensors 1-5.



The house icon shows the selected remote sensor.

- To auto-scan between sensors, press and hold **CH** for 2 seconds. Each sensor's data will be displayed for 3 seconds.
- To end auto-scan, press **CH** or **MEM** with the Temperature / Humidity Area selected.

NOTE If you select a sensor that collects only temperature data, the humidity will not be shown.

MINIMUM / MAXIMUM RECORDS

- Press **MEM** repeatedly to view current, maximum and minimum records for the selected sensor.
- To clear the records, press and hold **MEM** for 2 seconds. A beep will sound to confirm that the memory has been cleared.

TEMPERATURE AND HUMIDITY TREND

The trend lines are shown next to the temperature and humidity readings.

TREND	RISING	STEADY	FALLING
TEMPERATURE			
HUMIDITY			

COMFORT ZONE

The Comfort Zone indicates how comfortable the climate is, based on current temperature and humidity measurements.

ZONE	TEMPERATURE	HUMIDITY
WET	Any	>70%
COM	20-25°C (68-77°F)	40-70%
DRY	Any	<40%

NOTE This information is shown in the Humidity Area when the current measurement is displayed.

HEAT INDEX

The Heat Index advises 4 levels of warning if the temperature is high.

DANGER CATEGORY	TEMPERATURE	
	°C	°F
Extreme Danger	>54.5	>130
Danger	40.5-54.4	105-130
Extreme Caution	32.2-40.5	90-105
Caution	26.6-32.2	80-90

1. Press **SEL** to navigate to the Temperature Area. ▼

will show next to the Area.

2. Press **MODE** to reach the Heat Index display.
3. Press **CH** to select the desired channel.

NOTE If the temperature is below 26°C / 80°F, or the desired channel is not working, the Heat Index will display "NA".

BACKLIGHT

Press **SNOOZE / LIGHT** to illuminate the backlight for 8 seconds.

RESET SYSTEM

The **RESET** button is located in the main unit battery compartment. Press **RESET** when you change the batteries and whenever performance is not behaving as expected (for example, unable to establish radio frequency link with remote unit or radio-controlled clock).

NOTE When you press **RESET**, all settings will return to default value, and you will lose all stored information.

SAFETY AND CARE

Clean the product with a slightly damp cloth and alcohol free, mild detergent. Avoid dropping the product or placing it in a high-traffic location.

WARNINGS

This product is designed to give you years of service if handled properly. Oregon Scientific will not be responsible for any deviations in the usage of the device from those specified in the user instructions or any unapproved alterations or repairs of the product. Observe the following guidelines:

- Never immerse the product in water. This can cause electrical shock and damage the product.
- Do not subject the main unit to extreme force, shock, or fluctuations in temperature or humidity.
- Do not tamper with the internal components.
- Do not mix new and old batteries or batteries of different types.
- Do not use rechargeable batteries with this product.
- Remove the batteries if storing this product for a long period of time.
- Do not scratch the LCD display.

NOTE The technical specification of this product and contents of this user guide are subject to change without notice. Images not drawn to scale.

TROUBLESHOOTING

PROBLEM	SYMPTOM	REMEDY
Barometer	Strange readings	Set altitude / unit
Calendar	Strange date / month	Change language
Clock	Cannot adjust clock	Disable radio-controlled clock
	Cannot auto-synch	<ol style="list-style-type: none"> 1. Adjust batteries 2. Press RESET 3. Manually activate radio-controlled clock
Temp	Shows "LLL" or "HHH"	Temperature is out-of-range
Remote sensor	Cannot locate remote sensor	Check batteries

**SPECIFICATIONS****Main Unit Dimensions**

L x W x H	195 x 26 x 192 mm (7.6 x 0.8 x 7.5 inches)
Weight	578 grams (20.4 ounces) without battery

Remote Unit Dimensions

L x W x H	70 x 24.5 x 116 mm (2.76 x 0.96 x 4.57 inches)
Weight	108 grams (0.24 lbs) without battery

Temperature

Unit	°C or °F
Indoor Range	-5 °C to 50 °C (23 °F to 122 °F)
Outdoor Range	-20 °C to 60 °C (-4 °F to 140 °F)
Resolution	0.1 °C (0.2 °F)
Comfort	20 °C to 25 °C (68 °F to 77 °F)
Memory	Min / Max

Relative Humidity

Range	25% to 95%
-------	------------

Resolution	1%
Comfort	40% to 70%
Memory	Min / max

Barometer

Unit	mb / hPa or inHg
Resolution	1 mb (0.03 inHg)
Altitude	-100 to 2500 metres (-328 to 8202 feet)
Display	Sunny (day / night), partly cloudy (day / night), cloudy, rainy, snowy

Remote Unit (RTGR328N)

RF frequency	433 MHz
Range	Up to 70 metres (230 feet) with no obstructions
Transmission	Approx. every 1 minute
Channel No.	1, 2, 3, 4 or 5
Unit	°C or °F

Radio-Controlled Clock

Synchronization	Auto or disabled
Clock display	HH:MM:SS

Hour format	12hr AM/PM (MSF format) 24hr (DCF format)
Calendar	DD / MM or MM / DD; Day of the week in 1 of 5 languages (E, G, F, I, S)
Alarm	Daily & Pre-Alarm; 2-minute crescendo
Snooze	8-minute snooze

Power**Main Unit**

Batteries 4 x UM-3 (AA) 1.5V

Thermo / Hygro Remote Unit

Batteries 2 x UM-3 (AA) 1.5V

NOTE It is recommended that you use alkaline batteries with this product for longer performance.

ABOUT OREGON SCIENTIFIC

Visit our website (www.oregonscientific.com) to learn more about Oregon Scientific products such as digital cameras; MP3 players; children's electronic learning products and games; projection clocks; health and fitness gear; weather stations; and digital and conference phones. The website also includes contact information for our Customer Care department in case you need to reach us, as well as frequently asked questions and customer downloads.

We hope you will find all the information you need on our website, however if you're in the US and would like to contact the Oregon Scientific Customer Care department directly, please visit:

www2.oregonscientific.com/service/default.asp

OR

Call 1-800-853-8883.

For international inquiries, please visit:

www2.oregonscientific.com/about/international.asp



EU-DECLARATION OF CONFORMITY

Hereby, **Oregon Scientific**, declares that this Wireless Weather Station with World Time Clock model BAR916HG is in compliance with the essential requirements and other relevant provisions of Directive 1999/5/EC.

A copy of the signed and dated Declaration of Conformity is available on request via our Oregon Scientific Customer Service.



COUNTRIES RTTE APPROVAL COMPLIED

All EU countries, Switzerland (CH)

and Norway (N)

