

100 LAP STOPWATCH

MODEL NO.: SL928D

User Manual

INTRODUCTION

Congratulations on your purchasing the SL928D 100 Lap Stopwatch. A reliable timepiece for an active lifestyle, the SL928D is equipped with additional functions such as a multi-step pacer, count-down and count-up timer, and EL back light.

MAIN FEATURES

Refer to (FIG. 1).

A. [LAP/RESET] BUTTON

Registers a lap or resets, reset stop watch and timer, changes or decreases a value

B. [] BUTTON

Operates the back light

C. [MODE] BUTTON

Changes an operating mode or enters a setting procedure

D. [START/STOP] BUTTON

Starts or stops the stopwatch, timer or pacer, changes or increases a value

E. [RECALL] INDICATOR

Indicates the **RECALL** function is active

F. [LAP] INDICATOR

Indicates the number of laps

G. [CHRONO] INDICATOR

Indicates the **CHRONO** mode

H. [] INDICATOR

Indicates the daily alarm is active

I. [**CUM] INDICATOR**

Indicates the accumulated time

J. [**SEGMENT] INDICATOR**

Indicates the number of segments in a counting

K. [] INDICATOR

Indicates the **AUTO LIGHT** function is active

L. [**LAP] INDICATOR**

Indicates the lap time

M. [**PACER] INDICATOR**

Indicates the **PACER** mode

N. [**TIMER] INDICATOR**

Indicates the **TIMER** mode

O. [**SPL] INDICATOR**

Indicates the split time

P. [**FREE] INDICATOR**

Indicates the effective memory left for laps

Q. SAFETY CORD



Uses to secure the unit on hand or hanging the unit around the neck

DISPLAY MODES

Refer to (FIG. 2).

BACK LIGHT AND AUTO LIGHT

Refer to (FIG. 3).

Press [] to turn on the back light for five seconds. To activate the **AUTO LIGHT** function, press and hold [] for two seconds. Press and hold [] again to deactivate it. When the function is active, pressing any button will turn on the back light for five seconds.

TIME AND CALENDAR DISPLAY

Refer to (FIG. 4).

HOW TO SET THE CALENDAR CLOCK

Refer to (FIG. 5).

Note:

- a. Clock in either 24-hour or 12-hour (with “a” and “p” indication) format.
- b. Calendar year can be set between 2000 to 2099. The unit will automatically recognize the day of the week.
- c. Minute digit will be auto-advanced by one digit if second is reset after 30 sec.

HOW TO USE THE CHRONOGRAPH

Refer to (FIG. 6).

1. Press [**MODE**] to display the **CHRONO** mode.
2. To register a segment, press [**LAP/RESET**].
3. Press [**START**] to start counting. The stopwatch can count up to 23 hours, 59 minutes and 59.99 seconds before starting from zeros again.
4. Press [**STOP**] to stop counting. To resume, press [**START**]. A new lap count will start.
5. Or press [**LAP/RESET**]. The last lap number will appear and the display will freeze for five seconds. The [**CHRONO**] indicator will flash indicating the stopwatch is still running in the background.
6. Press [**STOP**] to stop counting.
7. Repeat the last three steps to register other laps. The stopwatch can register up to 100 laps.
8. Press [**LAP/RESET**] after stopping to clear the display and register another segment.

Note:

- a. The stopwatch can register up to 30 segments.
- b. 30 segments share with total 100 lap memories.

- c. The effective memory left for laps will be reduced as the number of registered segments increased.
- d. The free memory remained will be shown on the display when a segment is registered.
- e. Chronograph mode can be run at the background when the stopwatch is started and go to the other display mode.
- f. Stopwatch can still be operated of all segment on lap memory is being used up.

HOW TO SELECT THE CHRONOGRAPH IN UNITS OF HOURS, MINTUES OR SECONDS

Refer to (FIG. 7).

Note:

- a. Four different chronograph units of display: hour:minute:second with 1/100 sec. resolution, second with 1/100 sec. resolution; hour with 1/100000 hr resolution and minute with 1/1000 min resolution.
- b. Different segment can have different chronograph unit of display.
- c. Within each segment it is allowed only one single unit of display.

HOW TO RECALL CHRONOGRAPH RECORDS

Refer to (FIG. 8).

Note:

- a. The last recorded segment will be displayed with its time and date stamp when advance from chronograph mode.
- b. Two beeping sounds will be heart to indicate the end of lap record for each segment.

HOW TO ERASE CHRONOGRAPH RECORDS

Refer to (FIG. 9A / FIG. 9B).

Note: The record of the current running chronography cannot be deleted.

HOW TO USE THE TIMER

Refer to **(FIG. 10)** for timer setting mode.

Refer to **(FIG. 11)** for timer running mode.

Note:

- There are three modes of operation can be chosen : **CS** (count down and stop), **CU** (count down and count up) or **CR** (count down, automatic reload and repeat).
- The maximum count down or count up time is 23 hours, 59 minutes and 59 seconds. A pre-alert tone will be emitted at five second before completion of a count cycle and an alert tone will be emitted for 10 sec. upon the completion of a count cycle. Press any button to mute the alert tone.
- Timer can be run at the background when the timer is started and go to the other mode of display.

HOW TO USE THE PACER

Refer to **(FIG. 12)**.

Note:

- Pacer range from 30 to 240 at five-step intervals, i.e. number of beeping sound to be heard will be range from 30 beep per minute to 240 beep per mintue.
- Pacer can be run simultaneously with Chronograph mode. Beeping sound will be heard and flashing "PACER" icon will be seen during the stopwatch running mode if pacer is activated.

HOW TO USE THE DAILY ALARM

Refer to **(FIG. 13)**.

Note:

- The alarm will be automatically activated during the setting procedure.
- When the alarm is active, an alert tone will go off at 30 seconds. Press any key to mute the tone.

AUTO RETURN

In all setting procedures, the unit will automatically save all changes and return to the previous operating mode if no button is pressed for 30 seconds.

HOW TO USE THE SAFETY CORD

Refer to **(FIG. 14)**.

1. Thread the safety cord through the safety cord holder on the unit.
2. Loop and tighten the cord until it is in place.

BATTERY INFORMATION

Refer to **(FIG. 15)**.

The unit uses a CR2032 lithium 3V battery, which is installed in the factory for you. Under normal circumstances, the battery is good for years. Should you need to change the battery,

1. Open the battery compartment door.
2. Insert the battery strictly according to the polarities shown therein.
3. Replace the battery compartment door.

Note:

Change the battery when the display becomes dim.

PRECAUTIONS

This unit is engineered to give you years of satisfactory service if handled carefully.

1. Do not immerse the unit in water.
2. Do not clean the unit with abrasive or corrosive materials.
3. Do not subject the unit to snow or excessive force, shock, dust, temperature or humidity.
4. Do not tamper with the unit's internal components.

SPECIFICATIONS

| | |
|-----------------------|--------------------------------------|
| Real time clock | : 12/24 hour with hour/minute/second |
| Stop watch | : 00:00:00 to 23:59:59 (hrs:min:sec) |
| Timer: | : 00:00:00 to 23:59:59 (hrs:min:sec) |
| Pacer | : 30-240 beeps per minute |
| Power | : 1pcs CR2032 3V battery |
| Operating temperature | : -10°C to +50°C (14°F to 122°F) |
| Storage temperature | : -20°C to +60°C (-4°F to 140°F) |
| Weight | : 52 g (including battery) |

ABOUT OREGON SCIENTIFIC

Visit our website (www.oregonscientific.com) to learn more about Oregon Scientific products such as digital cameras; MP3 players; children's electronic learning products and games; projection clocks; health and fitness gear; weather stations; and digital and conference phones. The website also includes contact information for our customer care department in case you need to reach us, as well as frequently asked questions and customer downloads.

We hope you will find all the information you need on our website, however if you'd like to contact the Oregon Scientific Customer Care department directly, please visit:

www2.oregonscientific.com/service/support



OR

Call 949-608-2848 in the US.



For international enquiries, please visit:

<http://www2.oregonscientific.com/about/international/default.asp>



GB

- LEGENDE : *ITALIC* - PRESS
- ITALIC* - PRESS & HOLD FOR 2 SEC.
-  - FLASHING
-  - FAST ADVANCE



F

- LEGENDE : *ITALIQUES* - APPUYER
- ITALIQUES* - APPUYER PENDANT 2 SEC.
-  - CLIGNOTE
-  - AVANCE RAPIDE



D

- LEGENDE : *KURSIV* - DRÜCKEN
- KURSIV* - 2 SEKUNDEN LANG DRÜCKEN
-  - BLINKT
-  - SCHNELLER VORLAUF



I

- LEGENDA : *CORSIVO* - PREMERE
- CORSIVO* - TENERE PREMUTO PER DUE SECONDI
-  - LAMPEGGIANTE
-  - AVANZAMENTO RAPIDO

ES

- CLAVE : *CURSIVAS* - PULSE
- CURSIVAS* - PULSE Y SOSTENGA POR 2 SEG.
-  - PARPADEA
-  - AVANCE RAPIDO

P

- LEGENDAS : *ITÁLICO* - PRESSIONAR
- ITÁLICO* - RESSIONAR DURANTE DOIS SEGUNDOS
-  - LUZ INTERMITENTE
-  - AVANÇAR RAPIDAMENTE

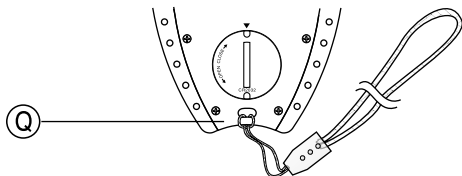
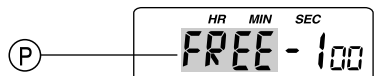
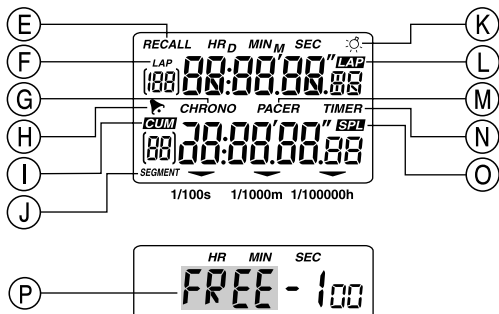
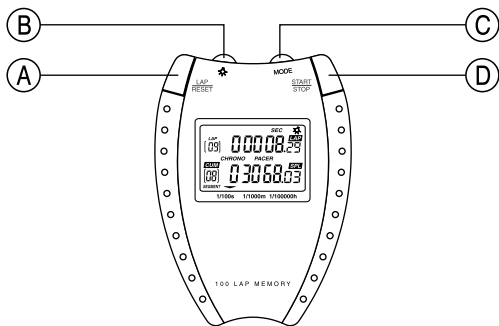

[FIG. 1]

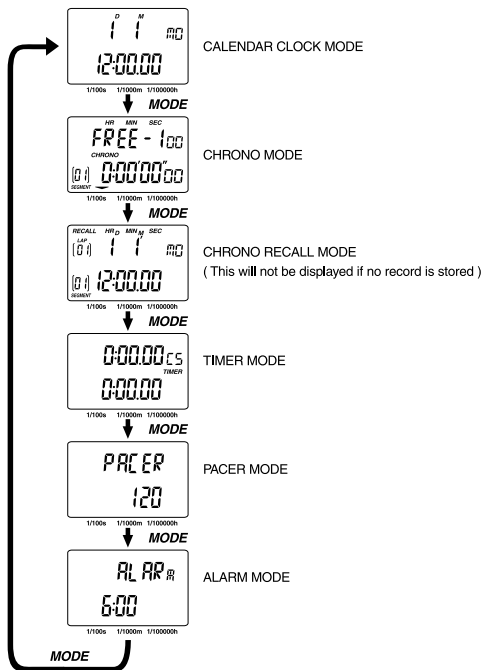

[FIG. 2]

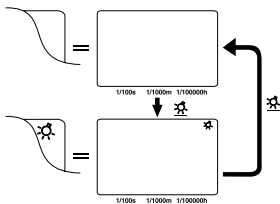

[FIG. 3]

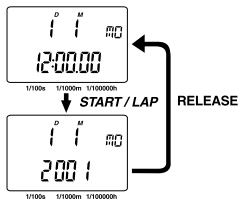

[FIG. 4]

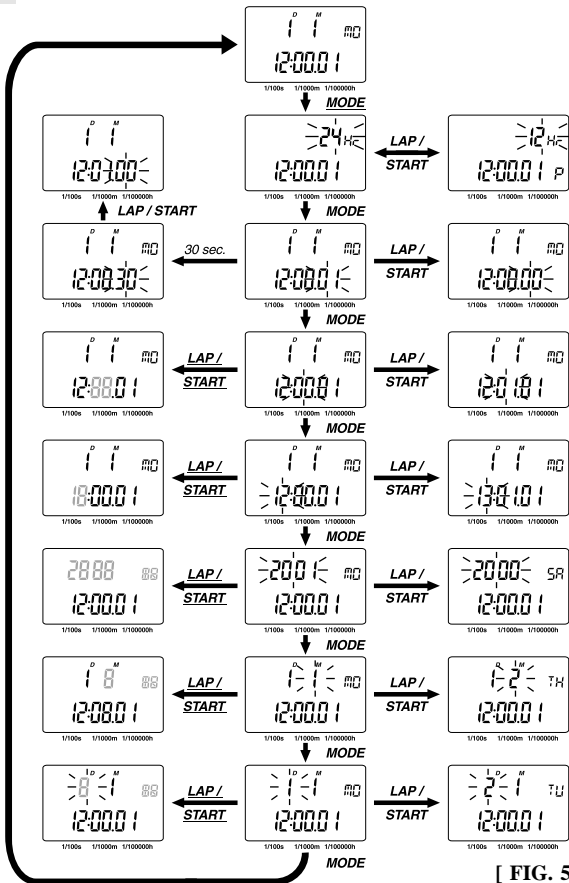

[FIG. 5]

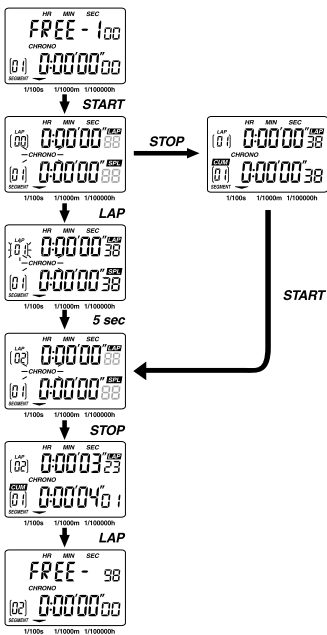

[FIG. 6]

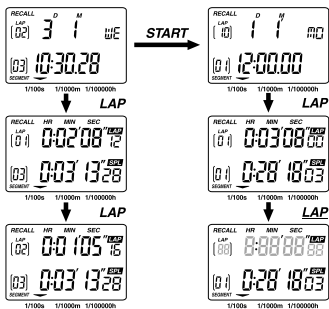

[FIG. 8]

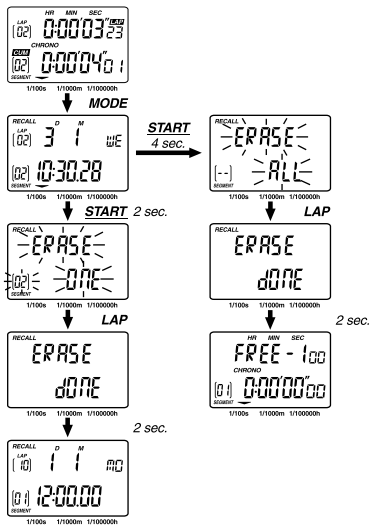

[FIG. 9A]

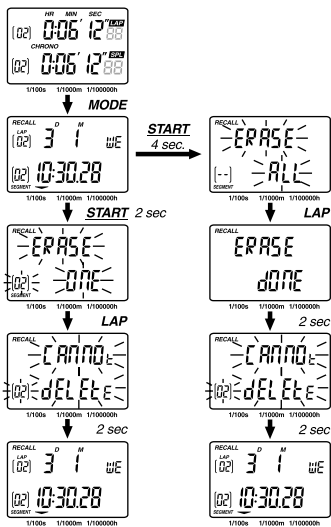

[FIG. 9B]

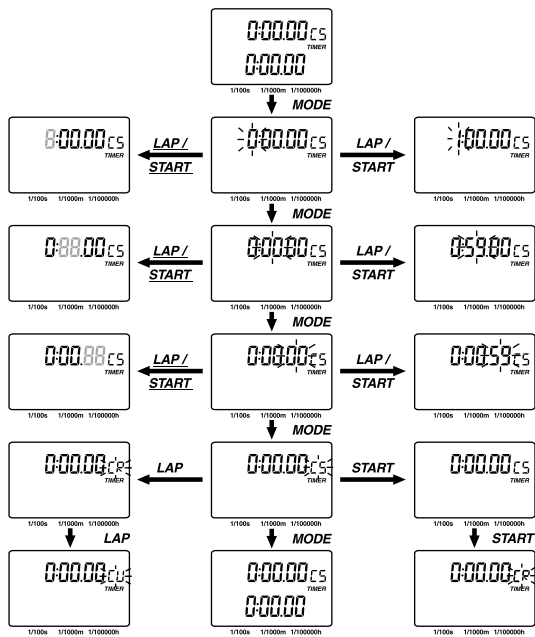

[FIG. 10]

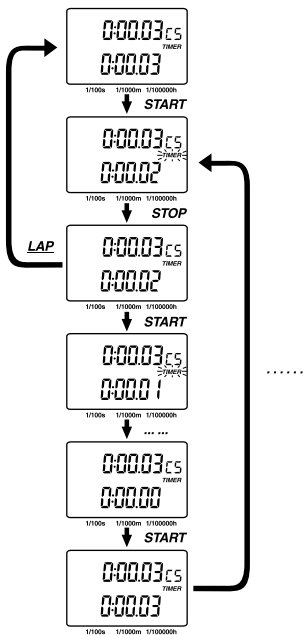

[FIG. 11]

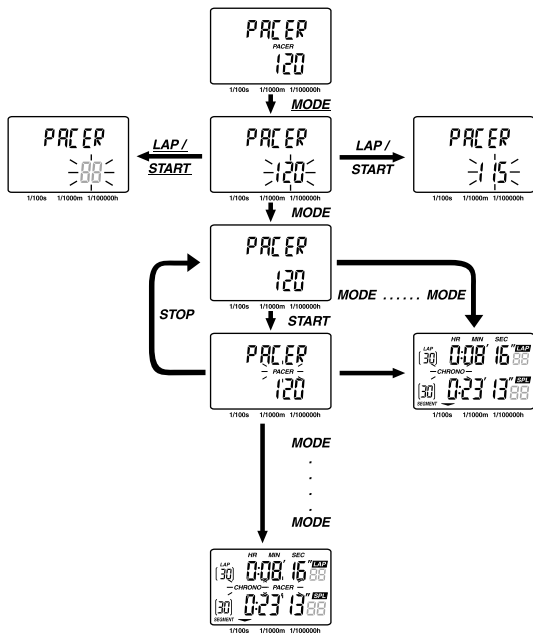

[FIG. 12]

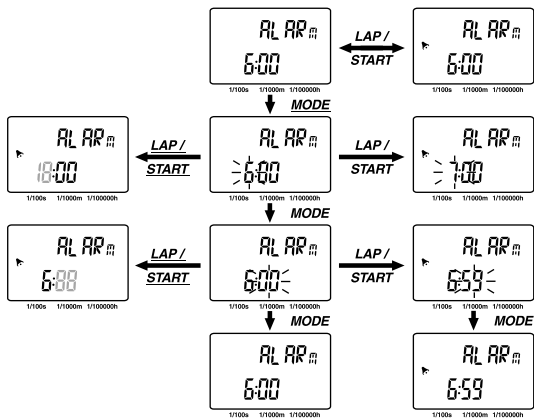

[FIG. 13]

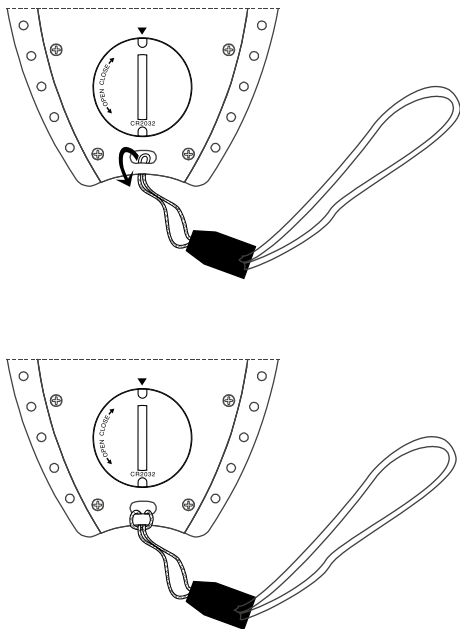
**[FIG. 14]**

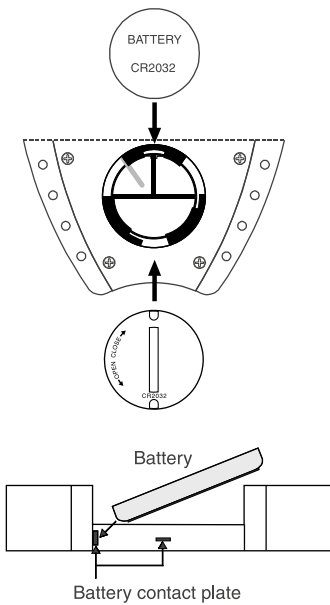

[FIG. 15]