

[ FIG. 1 ]

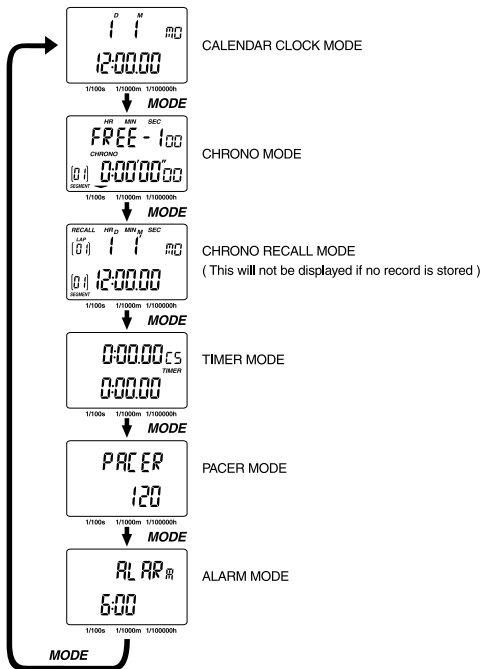

[ FIG. 2 ]

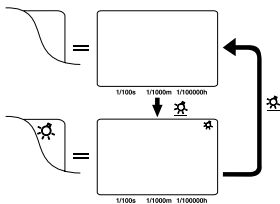

[ FIG. 3 ]

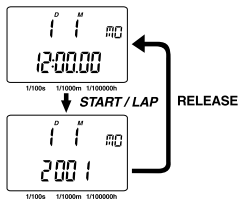

[ FIG. 4 ]

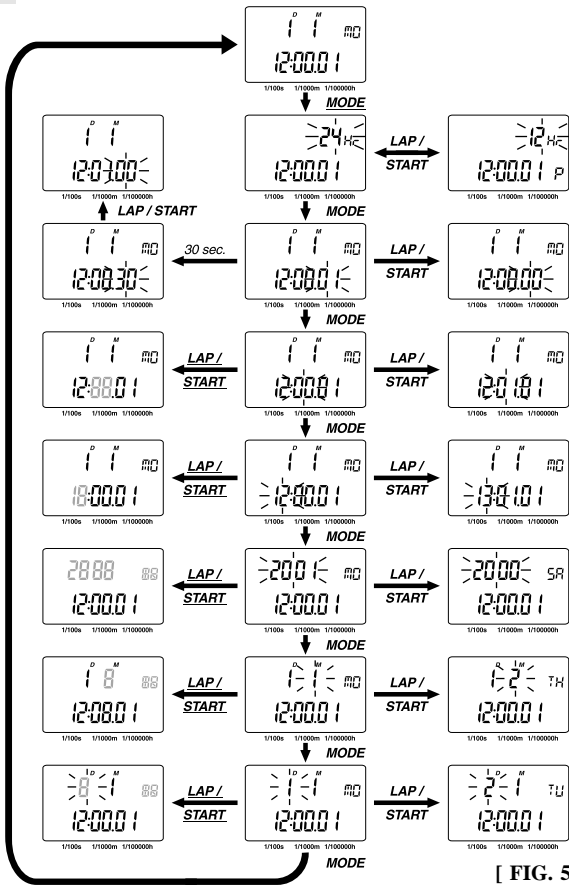

[ FIG. 5 ]

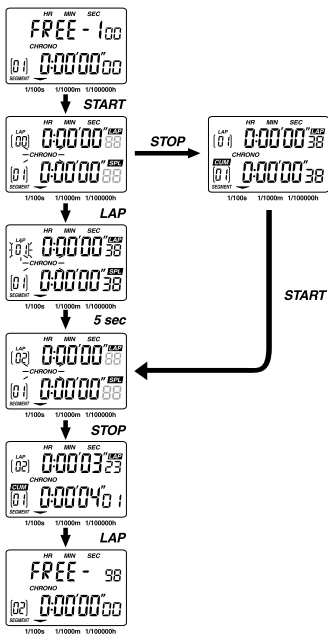

[ FIG. 6 ]

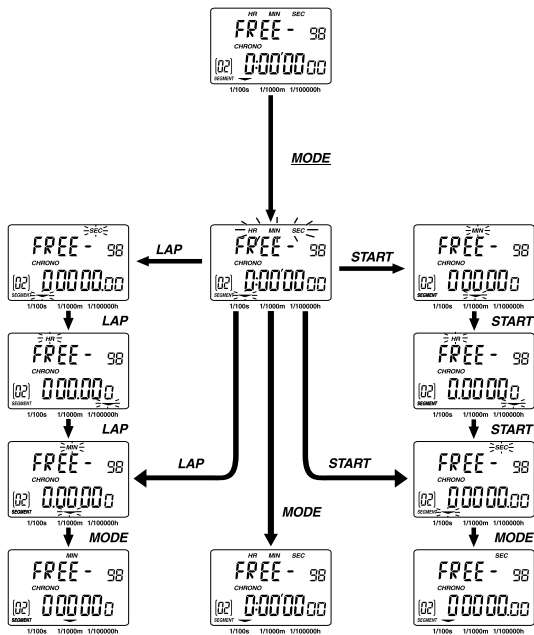

[ FIG. 7 ]

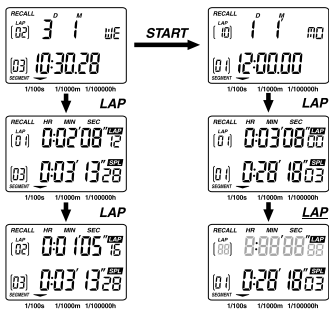

[ FIG. 8 ]

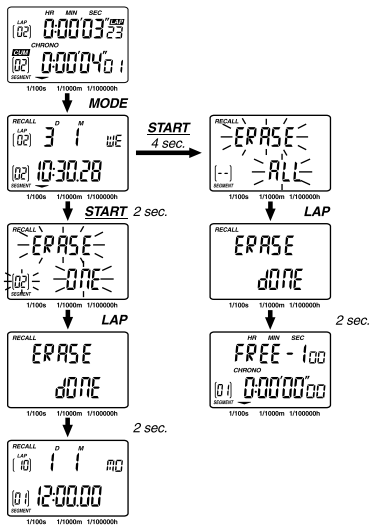

[ FIG. 9A ]



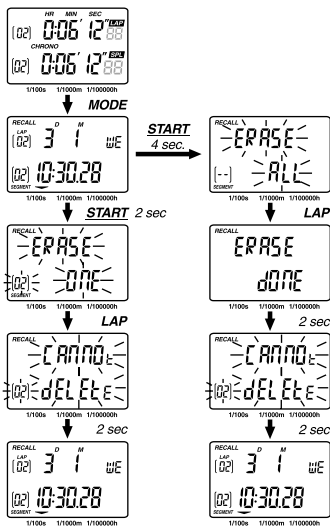

[ FIG. 9B ]

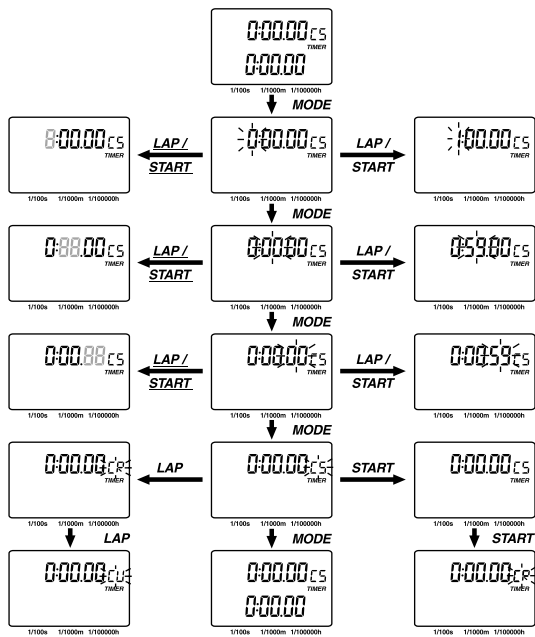

[ FIG. 10 ]

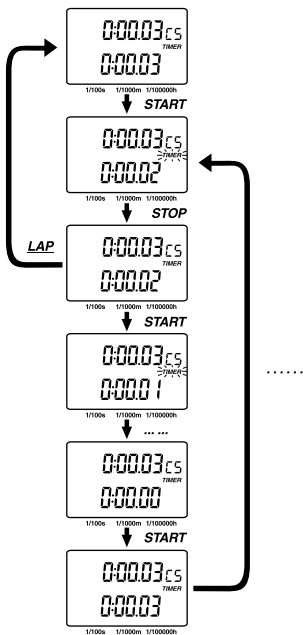

[ FIG. 11 ]

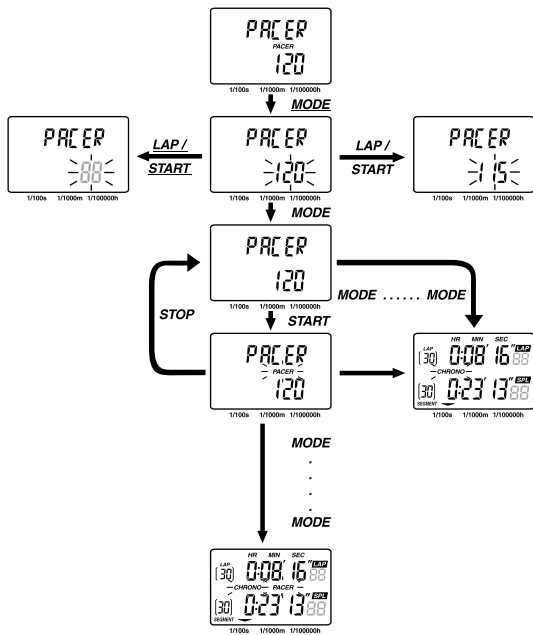

[ FIG. 12 ]

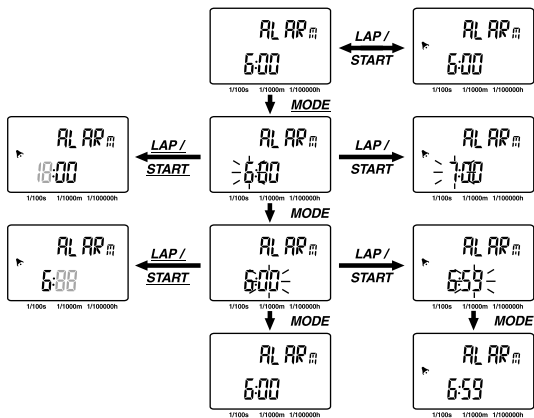

[ FIG. 13 ]

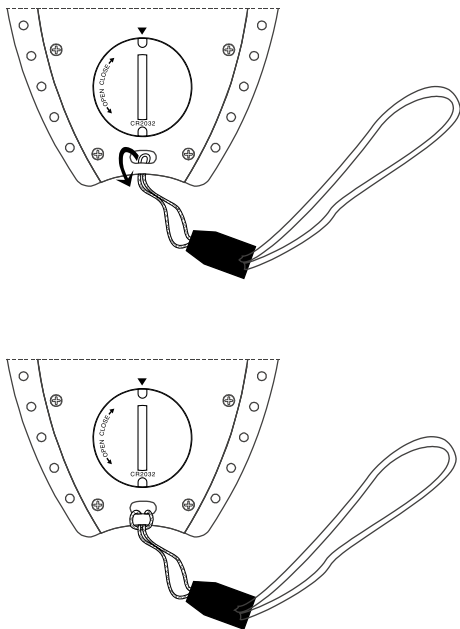
**[ FIG. 14 ]**

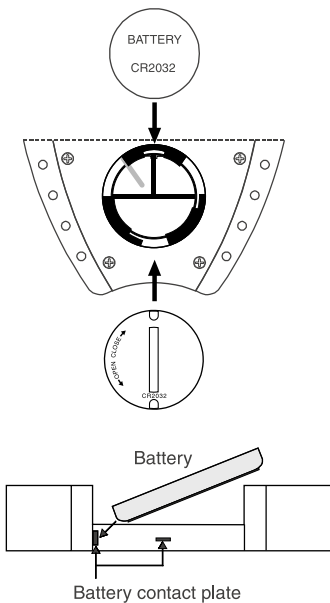

[ FIG. 15 ]