



Test Report issued under the responsibility of:



TEST REPORT	
IEC 61558-2-17	
Safety of power transformers, power supply units and similar	
Part 2: Particular requirements for transformers for switch mode power supplies	
Report	
Reference No.	: GZ09061312-1
Tested by (+ signature).....	: Sonny Yan
Approved by (+ signature)	: Justin He
Date of issue	: 21 JUL 2009
Contents.....	: 51 Pages
This report is based on a blank test report that was prepared by KEMA using information obtained from the TRF originator (see below).	
Testing laboratory	
Name	: Intertek Testing Services Shenzhen Ltd. Guangzhou Branch
Address	: Block E, No.7-2 Guang Dong Software Science Park, Caipin Road, Guangzhou Science City, GETDD, Guangzhou, China
Testing location	: as above
Client	
Name	: Lygo International Co., Ltd.
Address	: Unit 1902, 19/F., Prosperity Plaza, 6 Shing Yip Street, Kwun Tong, Kowloon, Hong Kong
Test specification	
Standard	: IEC 61558-2-17:1997; IEC 61558-1:1997 + A1:1998; IEC 61558-2-6:1997; EN 61558-2-17:1997; EN 61558-1:1997 + A1:1998 + A11:2003, EN 61558-2-6: 1997
Test procedure	: CB-scheme, GS, LVD
Procedure deviation	: N.A.
Non-standard test method	: N.A.
Test Report Form/blank test report	
Test Report Form No.	: I558217A/99-03
TRF originator.	: VDE
Master TRF	: reference No. Y2500117, dated 98-08
Copyright reserved to the bodies participating in the IECEE CB and/or the bodies participating in the CENELEC Certification Agreement (CCA).	

Intertek Testing Services Shenzhen Ltd. Guangzhou Branch

Block E, No.7-2 Guang Dong Software Science Park, Caipin Road, Guangzhou Science City, GETDD, Guangzhou, China

Tel: (86 20) 8213 9688 Fax: (86 20) 3205 7538 Website: www.china.intertek-etlsemko.com

Test item	
Description	Switching Power Supply
Trademark	LG
Model and/or type reference.....	LGSPSAxxxxxyzz
Manufacturer	Same as applicant
Rating(s).....	Input: 100-240Vac, 50/60Hz, 190mA
.....	Output: 2,4V-24,1Vdc, 0,05-1,5A, 8,5 W max.
Particulars: test item vs. test requirements	
Type of transformers.....	Safety isolating transformer
Application	Portable
Protection against electric shock.....	Class II
Short-circuit protection	
- inherently short-circuit proof	No
- non-inherently short-circuit proof.....	Yes
- non short-circuit proof.....	No
- fail-safe.....	No
Protection index	N/A (ordinary transformer)
Other characteristics	N/A
Rated ambient temperature ta (°C)	25°C
Short-circuit voltage (V)	N/A
Test case verdicts	
Test case does not apply to the test object.....	N(.A.)
Test item does meet the requirement	P(ass)
Test item does not meet the requirement	F(ail)
.....	
Testing	
Date of receipt of test item	24 JUN 2009
Date(s) of performance of test.....	24 JUN 2009 – 21 JUL 2009

General remarks

"This report is not valid as a CB Test Report unless appended to a CB Test Certificate issued by a NCB, in accordance with IEC 02".

This test report shall not be reproduced except in full without the written approval of the testing laboratory.

The test results presented in this report relate only to the item tested.

Throughout this report a comma is used as the decimal separator.

When determining the test conclusion, the Measurement Uncertainty of test has been considered.

This report is for the exclusive use of Intertek's Client and is provided pursuant to the agreement between Intertek and its Client. Intertek's responsibility and liability are limited to the terms and conditions of the agreement. Intertek assumes no liability to any party, other than to the Client in accordance with the agreement, for any loss, expense or damage occasioned by the use of this report. Only the Client is authorized to permit copying or distribution of this report and then only in its entirety. Any use of the Intertek name or one of its marks for the sale or advertisement of the tested material, product or service must first be approved in writing by Intertek. The observations and test results in this report are relevant only to the sample tested. This report by itself does not imply that the material, product, or service is or has ever been under an Intertek certification program.

The test report only allows to be revised only within the report defined retention period unless standard or regulation was withdrawn or invalid.

The clause which indicated with * is the subcontract test item.

This report consists of:

- Main report 1 to 51;
- Appendix 1 (1 page): A1:1998 to IEC 61558-1:1997
- Appendix 2 (3 pages): Relevant requirement of IEC 61558-2-6:1997
- Appendix 3 (4 pages): National deviation
- Appendix 4 (2 pages): Components
- Appendix 5 (1 page): Circuit diagram
- Appendix 6 (1 page): PCB layout
- Appendix 7 (7 pages): Photos
- Appendix 8 (1 pages): Instruction manual
- Appendix 9 (12 page): Plug portion

**Copy of marking plate
(Representative)**

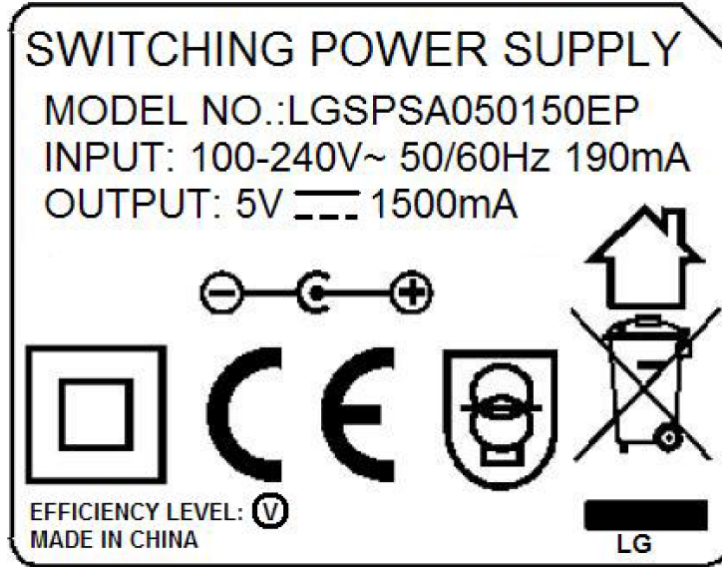

English version



German version

Note: The above markings are the minimum requirements required by the safety standard. For the final production samples, the additional markings which do not give rise to misunderstanding may be added.

General product information:

Model LGSPSAxxxxyyzz

The “xxx” denote output voltage, which can be 024 (2,4 Vdc) to 241 (24,1 Vdc);

The “yy” denote output current, which can be 005 (50 mA) to 150 (1500 mA);

The “zz” denote the type of input plug, which can be EP, BS, UL, AU, “EP” for European plug, “BS” for British Plug, “UL” for American Plug, “AU” for Australia Plug.

Output power: 8,5 W max.



All models have same circuit diagram, PCB layout except for output rating and transformer T1 (total 3 transformers are used for this series correspond to different output voltage, those transformers has same construction except turns of windings N3). For the output current, the minimum rise step is 0,01A. For the output voltage, the minimum rise step is 0,1V



The selected models for the test are LGSPSA024150zz, LGSPSA100085zz, LGSPSA241010zz and LGSPSA240035zz.



As requirement by the applicant, 0,9 and 1,1 times of input voltage and 40°C ambient condition have been considered

Manufacturing site: Lygo Electronic Products Mfy.

Xingsi Administrative Zone, Hengli, Dongguan, Guangdong, P. R. China

IEC 61558-2-17			
Clause	Requirement – Test	Result - Remark	Verdict
8	MARKING AND OTHER INFORMATION		P
8.1	Transformer marked with:		P
	a) rated supply voltage or voltage range (V)	100 – 240 Vac	P
	b) rated output voltage (V)	2,4 – 24,1 Vdc	P
	c) rated output (VA, kVA or W)		N/A
	d) rated output current (A)	0,05 – 1,5 A	P
	e) rated frequency (Hz)	50 / 60 Hz	P
	f) rated power factor (if not 1)		N/A
	g) symbol for nature of output current for transformers with rectifier		P
	h) symbol for electrical function (according to Part 2)		P
	i) manufacturer's name or trademark	LG	P
	j) model or type reference	LGSPSAxxxxxyzz (details see page 4)	P
	k) vector group according to IEC 76 for three-phase transformer		N/A
	l) symbol for Class II		P
	m) symbol for Class III		N/A
	n) index IP (if not IP00 or IP20) or ordinary transformer	ordinary transformer	N/A
	o) rated max. ambient temperature ta (if not 25 °C)		N/A
	p) short-time operation or intermittent operation: rated operating and resting time	Continuous operation	N/A
	- short-circuit voltage (% rated supply voltage) for stationary transformers > 1000 VA	Potable transformer	N/A
8.2	Marking for transformers IP00 or for associated transformers: type and trademark, instruction sheets	Independent transformer	N/A
8.3	Adjusted voltage easily and clearly discernible		N/A
8.4	For each tapping or winding: rated output voltage and rated output		N/A
8.5	Symbol for short-circuit proof transformers or non-inherently short-circuit proof transformers		P

IEC 61558-2-17			
Clause	Requirement – Test	Result - Remark	Verdict
	Rated current (A or mA) and symbol for time current characteristics of the fuses for non-inherently short-circuit proof transformer with incorporated fuses and non-short-circuit proof transformer		N/A
	Manufacturer's model or type reference and rating of the device for non-inherently short-circuit proof transformers with incorporated replaceable protective device (other than fuses)		N/A
	Characteristic symbol for fail-safe transformers		N/A
8.6	Terminals for neutral: "N"		N/A
	Terminal for earthing		N/A
	Identification of input terminals: "PRI"		N/A
	Identification of output terminals: "SEC"		N/A
	Symbol for any point/terminal in connection with frame or core		N/A
8.7	Indication for correct connection		N/A
8.8	Instruction sheet for type X, Y, Z attachments	Type Z attachments for output cord	P
8.9	Transformer for indoor use shall be marked on the label or in the instruction sheet with the words: "for indoor use only"	 , See page 2	P
8.10	Symbol for Class II construction not confused with maker's name or trademark		P
8.11	Correct symbols:		P
	Volts		P
	Amperes		P
	Volt amperes (or volt-amperes reactive for reactors)		N/A
	Watts		N/A
	Hertz		P
	Input		P
	Output		P
	Direct current		P
	Neutral		N/A
	Single-phase a.c.		P
	Three-phase a.c.		N/A
	Three-phase and neutral a.c.		N/A

IEC 61558-2-17			
Clause	Requirement – Test	Result - Remark	Verdict
	Power factor		N/A
	Class II construction		P
	Class III construction		N/A
	Fuse-link		N/A
	Rated max. ambient temperature		N/A
	Frame or core terminal		N/A
	Protective earth	Class II transformer	N/A
	IP number	Ordinary transformer	N/A
	For indoor use only (text)		P
	Fail-safe separating transformer (EN 61558-2-17:97)		N/A
	Non-short-circuit proof separating transformer (EN 61558-2-17:97)		N/A
	Short-circuit proof separating transformer (EN 61558-2-17:97)		N/A
	Fail-safe isolating transformer (EN 61558-2-17:97)		N/A
	Non-short-circuit proof isolating transformer (EN 61558-2-17:97)		N/A
	Short-circuit proof isolating transformer (EN 61558-2-17:97)		N/A
	Fail-safe safety isolating transformer (EN 61558-2-17:97)		N/A
	Non-short circuit proof safety isolating transformer (EN 61558-2-17:97)		N/A
	Short-circuit proof safety isolating transformer (EN 61558-2-17:97)		P
8.12	Figures, letters or other visual means for different positions of regulating devices and switches		N/A
	OFF position indicated by figure 0		N/A
	Greater output, input etc. indicated by higher figure		N/A
8.13	Marking not on screws or other easily removable parts		P
	Marking clearly discernible (transformer ready for use)		P
	Marking for terminals clearly discernible if necessary after removal of the cover		N/A

IEC 61558-2-17			
Clause	Requirement – Test	Result - Remark	Verdict
	Marking for terminals: no confusion between input and output		N/A
	Marking for interchangeable protective devices positioned adjacent to the base		N/A
	Marking for interchangeable protective devices clearly discernible after removal of cover and protective device		N/A
8.14	Special informations for installation if necessary		N/A
8.15	Marking durable and easily legible		P

9	PROTECTION AGAINST ACCESSIBILITY OF HAZARDOUS LIVE PARTS		P
9.1	Live parts are not hazardous live if:		P
	- in case of a plug: 5 s after the interruption of the supply the voltage between the pins shall not exceed 35 V (peak) a.c. or 60 V ripple free d.c.		P
	The live part is not hazardous live if separated from the supply by double or reinforced insulation (see 19.8) and between any parts of contacts the following values do not exceed:		P
	a) touch voltage < 35 V (peak) a.c. or 60 V d.c.	For output terminal: LGSPSA240035zz: 24,05Vdc; For L/N and secondary: LGSPSA240035zz: 194Vpk max;	P
	b) if the voltage higher than limited in a) touch current according to Annex J		P
	for a.c. U2: 0,35 V peak (0,7 mA peak)	Between L / N and output: LGSPSA240035zz: 0,118Vpk	P
	for d.c. U1: 1 V d.c. peak (2 mA d.c.)		N/A
	for a.c. U1: 35 V peak (70 mA a.c. higher frequencies)	Between L / N and output: LGSPSA240035zz: 11Vpk.	P
	c) discharge: < 50 μC (between 60 V and 15 kV)	0,006 uC Max.	P
	d) energy: < 350 mJ (> 15 kV)		N/A
9.2	Safety isolating transformers (EN 61558-2-17:97):		P
	- if the no-load output voltage is ≤ 35 V peak a.c. or ≤ 60 V ripple free d.c., live parts may be accessible (EN 61558-2-17:97)		P
	Transformers > IP00 shall have an adequate protection against accidental contact:		P

IEC 61558-2-17			
Clause	Requirement – Test	Result - Remark	Verdict
	- with hazardous live parts		P
	- with metal parts separated from hazardous live parts for Class II transformers by basic insulation even after removal of detachable parts except for:	No metal parts by basic insulation.	N/A
	- lamps with caps other than E10	No such device	N/A
	- type D fuse-carriers	No such device	N/A
	Isolating and safety isolating transformers (EN 61558-2-17:97):		P
	- if the no-load output voltage is > 35 V peak a.c. or > 60 V ripple free d.c. (EN 61558-2-17:97):		N/A
	- only one pole of parts connected to the output circuit may become accessible (EN 61558-2-17:97)		N/A
	Lacquers, enamel, paper, cotton, oxide film on metal parts not used for protection against accidental contact with hazardous live parts:		P
	- compliance is checked by inspection and by relevant tests according to IEC 60 529		N/A
	- ordinary transformer: test according to fig. 2 (test finger)		P
	- Class II transformers and Class II parts of Class I construction are tested with the test pin shown in fig. 3		P
	- hazardous live parts shall not be touchable by test finger		P
	- for Class II transformers: metal parts separated by basic insulation from hazardous live parts not touchable by test finger		P
	- hazardous live parts shall not be touchable with the test pin		P

10	CHANGE OF INPUT VOLTAGE SETTING		N/A
	Voltage setting not possible to change without a tool		N/A
	Different rated supply voltages:		N/A
	- indication of voltage on the transformer discernible		N/A

11	OUTPUT VOLTAGE AND OUTPUT CURRENT UNDER LOAD		P
11.1	Difference from rated value (without rectifier; with rectifier): with rectifier		P

IEC 61558-2-17			
Clause	Requirement – Test	Result - Remark	Verdict
	a) inherently short-circuit proof transformers with one rated output voltage for output voltage: ≤ 10%; ≤ 15%		N/A
	b) inherently short-circuit proof transformers with one more than 1 rated output voltage for highest output voltage: ≤ 10%; ≤ 15%		N/A
	c) idem for other output voltages: ≤ 15%; ≤ 20%		N/A
	d) other transformers for output voltages: ≤ 5%; ≤ 10% d.c.	See appended table	P

12	NO-LOAD OUTPUT VOLTAGE (see supplementary requirements in Part 2)		P
	Remark: with rectifier measuring on both sides of the rectifier		N/A
12.101	No-load output voltage (EN 61558-2-17:97):		P
	- separating transformers ≤ 1000 V a.c. or ≤ 1415 V ripple-free d.c. (EN 61558-2-17:97)		N/A
	- isolating transformers ≤ 500 V a.c. or ≤ 708 V ripple-free d.c. (EN 61558-2-17:97)		N/A
	- safety isolating transformers ≤ 50 V a.c. or ≤ 120 V ripple-free d.c. (EN 61558-2-17:97)	See appended table	P

13	SHORT-CIRCUIT VOLTAGE		N/A
	Difference from marking for short-circuit voltage ≤ 20%		N/A

14	HEATING		P
14.1	No excessive temperature in normal use		P
14.1.1	Classified material according to IEC 60 085 and IEC 60 216 insulating class temperature index	Class B	P
14.1.2	No classified material but the measured temperature does not exceed the value of Class A		N/A
14.1.3	No classified material but the measured temperature exceeds the value for Class A, the live parts of the transformers are submitted to the test of 14.3		N/A
14.2	Upri (V): 1,06 times rated supply voltage	See appended table	—
	Cos φ = rated power factor	N/A	—

IEC 61558-2-17			
Clause	Requirement – Test	Result - Remark	Verdict
	Room temperature: rated ambient temperature (°C)	See appended table	—
	Type X, Y, Z attachments: 1 pull (5 N) to the connection windings	For output cord	P
	Temperature of windings:		P
	- Class A: ≤ 100 °C		N/A
	- Class E: ≤ 115 °C		N/A
	- Class B: ≤ 120 °C	See appended table	P
	- Class F: ≤ 140 °C		N/A
	- Class H: ≤ 165 °C		N/A
	- other classes		N/A
	Temperature of external enclosures of stationary transformers:		N/A
	- metal: ≤ 70 K		N/A
	- other material: ≤ 80 K		N/A
	Temperature of external enclosure of stationary transformer ≤ 85 °C (not touchable with the IEC test finger)		N/A
	Temperature of external enclosures, handles, etc. of portable transformers:		P
	- continuously held parts of metal: ≤ 55 °C		N/A
	- continuously held parts of other material: ≤ 75 °C		N/A
	- not continuously held parts of metal: ≤ 60 °C		N/A
	- not continuously held parts of other material: ≤ 80 °C	See appended table	P
	Temperature of terminals for external conductors ≤ 70 °C		N/A
	Temperature of terminals of switches ≤ 70 °C		N/A
	Temperature of internal and external wiring:		P
	- rubber: ≤ 65 °C		N/A
	- PVC: ≤ 70 °C	By component's spec.: Internal wire: 105°C; Output cord: 80°C	P
	Temperature of parts where safety can be affected:		N/A
	- rubber: ≤ 75 °C		N/A
	- phenol-formaldehyde: ≤ 105 °C		N/A
	- urea-formaldehyde: ≤ 85 °C		N/A

IEC 61558-2-17			
Clause	Requirement – Test	Result - Remark	Verdict
	- impregnated paper and fabric: ≤ 85 °C		N/A
	- impregnated wood: ≤ 85 °C		N/A
	- PVC, polystyrene and similar thermoplastic material: ≤ 65 °C		N/A
	- varnished cambric: ≤ 75 °C		N/A
	Temperature rise of supports ≤ 85 °C	See appended table	P
	Temperature of printed boards:		P
	- bonded with phenol-formaldehyde: ≤ 105 °C		N/A
	- melamine-formaldehyde: ≤ 105 °C		N/A
	- phenol-furfural: ≤ 105 °C		N/A
	- polyester: ≤ 105 °C		N/A
	- bonded with epoxy: ≤ 140 °C		N/A
	Electric strength between input and output windings (18.3, 1 min); test voltage (V)	4200V	P
14.3	Cycling test (10 cycles):		N/A
	- no-load current (mA) (18.4)		N/A
	- no-load input (18.4)		N/A
14.3.1	- heat run (temperature in table 2)		N/A
14.3.2	- moisture treatment (48 h, 17.2)		N/A
14.3.3	- vibration test: 30 min; amplitude 0,35 mm; frequency range: 10 Hz, 55 Hz, 100 Hz		N/A
14.3.4	After each test:		N/A
	- insulation resistance (18.1 and 18.2)		N/A
	- electric strength, no breakdown (18.3); 2 min; test voltage 35% of specified value (table VI)		N/A
	- electric strength, no breakdown (18.4); no load; duration (min): 2 min; Upri (V): 2 times rated supply voltage; frequency (Hz): 2 times rated frequency		N/A
	- no-load current ≤ 30% (18.4) deviates from the first measurement		N/A
	- no-load input ≤ 30% (18.4) deviates from the first measurement		N/A
14.101	Switching frequencies ≤ 40 kHz (kHz) (EN 61558-2-17:97)		N/A
	Values of table 1 are used (EN 61558-2-17:97)		N/A

IEC 61558-2-17			
Clause	Requirement – Test	Result - Remark	Verdict
	Special specimen with a thermocouple or equivalent placed in the hottest area is used (EN 61558-2-17:97)		P

15	SHORT-CIRCUIT AND OVERLOAD PROTECTION		P
15.1	Upri (V): rated supply voltage factor	264 Vac (as requirement by the applicant)	—
	Max. temperature of winding protected inherently (insulation class): ≤ 150 °C (A); ≤ 165 °C (E); ≤ 175 °C (B); ≤ 190 °C (F); ≤ 210 °C (H)		N/A
	Max. temperature of winding protected by protective device during the time T given in table 4 (insulation class): ≤ 200 °C (A); ≤ 215 °C (E); ≤ 225 °C (B); ≤ 240 °C (F); ≤ 260 °C (H)		N/A
	Max. temperature of winding protected by protective device after first hour, peak value (insulation class): ≤ 175 °C (A); ≤ 190 °C (E); ≤ 200 °C (B); ≤ 215 °C (F); ≤ 235 °C (H)		N/A
	Max. temperature of winding protected by protective device after first hour, arithmetic mean value (insulation class): ≤ 150 °C (A); ≤ 165 °C (E); ≤ 175 °C (B); ≤ 190 °C (F); ≤ 210 °C (H)	See appended table	P
	Max. temperature of external enclosures (accessible by test finger) ≤ 105 °C	See appended table	P
	Max. temperature of insulation of wiring (rubber and PVC) ≤ 85 °C	See appended table	N/A
	Temperature rise of supports ≤ 105 °C	See appended table	P
	The specimen used for tests of Cl. 14 is also used for this subclause (EN 61558-2-17:97)		P
15.2	For inherently short-circuit proof transformers and for transformers with rectifiers: temperature rises ≤ values in table 3		N/A
15.3	For non-inherently short-circuit proof transformers and for transformers with rectifiers: temperature rises ≤ values in table 3		P
15.3.1	Output terminals short-circuited: protection device operates	See appended table	P
15.3.2	If protected by a fuse according to IEC 60 269-2 or IEC 60 269-3 or a technically equivalent fuse, transformer is loaded with time T and a current equal to k times values according to table 4	No such device used	N/A

IEC 61558-2-17			
Clause	Requirement – Test	Result - Remark	Verdict
15.3.3	If protected by a fuse according to IEC 60 127 or ISO 8820 or a technically equivalent fuse, transformer is loaded for the longest pre-arcing time with the redundant current as specified in the standard sheet	Protected by internal circuits	N/A
15.3.4	If protected by a circuit-breaker according to IEC 60 898 the transformer is loaded with a current equal to 1,45 times the value of the circuit-breaker	No such device used	N/A
15.3.5	If other overload protection than a fuse (IEC 60 127) or a circuit-breaker (IEC 60 898) test with 0,95 times of operating current		P
15.3.6	If thermal cut-outs, test with 0,95 times of operating current	No thermal cut-out used	N/A
15.4	For non-short-circuit proof transformers: temperature rises \leq values in table 3	Short-circuit proof transformer	N/A
15.5	For fail-safe transformers:		N/A
	- Upri (V): 1,06 times rated supply voltage		—
	- Isec (A): 1,5 times rated output current		—
	- time until steady-state conditions t1 (h)		—
	- time until failure t2 (h): \leq t1; \leq 5 h		N/A
	During the test:		N/A
	- no flames, molten material, etc.		N/A
	- temperature of enclosure \leq 175 °C		N/A
	- temperature of plywood support \leq 125 °C		N/A
	After the test:		N/A
	- electric strength (Cl. 18, 1 min, test voltage: 35% of specified value); no flashover or breakdown for primary-to-secondary only for safety isolating, isolating and separating transformer and for primary-to-body for all kinds of transformer		N/A
	- bare hazardous live parts not accessible by test finger through holes of enclosure		N/A

16	MECHANICAL STRENGTH		P
16.1	After tests of 16.2 and 16.3 and 16.4:		P
	- no damage		P
	- hazardous live parts not accessible by test pin according to 9.2		P

IEC 61558-2-17			
Clause	Requirement – Test	Result - Remark	Verdict
	- no damage for insulating barriers	No such device	N/A
	- handles, levers, etc. have not moved on shafts	No such device	N/A
16.2	For stationary and portable transformers: 3 blows, impact energy 0,5 Nm		P
16.3	For portable transformers: 100 falls, 25 mm		N/A
16.4	Transformers with integrated pins, the following tests are carried out:		P
	a) plug-in transformers: tumbling barrel test: 50 x ≤ 250 g; 25 x ≤ 250 g		P
	b) torque test of the plug pins with 0,4 Nm		P
	c) pull force according to table 5 for each pin		P

17	PROTECTION AGAINST HARMFUL INGRESS OF WATER AND MOISTURE		P
17.1	IP number marked on the transformer	Ordinary transformer	N/A
	Test according to 17.1.1 and for other IP ratings test according to IEC 60 529:		N/A
	- stable operating temperature before starting the test for < IPX8		N/A
	- transformer mounted and wired as in normal use		N/A
	- fixed transformer mounted as in normal use by the tests according to 17.1.1 A to J		N/A
	- portable transformers placed in the most unfavourable position and wired as in normal use		N/A
	- glands tightened with a torque equal to two-thirds of 25.6		N/A
	After the tests:		N/A
	- dielectric strength test according to 18.3		N/A
	Inspection:		N/A
	a) in dust-proof transformers no deposit of talcum powder		N/A
	b) no deposit of talcum powder inside dust-tight transformers		N/A
	c) no trace of water on live parts or insulation if hazard for the user or surroundings no reduction of creepage distances		N/A
	d) no accumulation of water in transformers ≥ IPX1 so as to impair safety		N/A
	e) no trace of water entered in any part of watertight transformer		N/A

IEC 61558-2-17			
Clause	Requirement – Test	Result - Remark	Verdict
	f) no entry into the transformer by the relevant test probe		N/A
17.1.1	Tests:		N/A
	A) Solid-object-proof transformers: first IP numeral 2 test finger (IEC 60 529) and test pin (fig. 3)		N/A
	B) Solid-object-proof transformers:		N/A
	- first IP numeral 3, wire 2,5 mm; force 3 N		N/A
	- first IP numeral 4, wire 1 mm; force 1 N		N/A
	C) Dust-proof transformers, first characteristic IP numeral 5; dust chamber according to IEC 60 529, fig. 2:		N/A
	a) transformer has operating temperature		N/A
	b) transformer, still operating, is placed in the dust chamber		N/A
	c) the door of the dust chamber is closed		N/A
	d) fan/blower is switched on		N/A
	e) after 1 min transformer is switched off for cooling time of 3 h		N/A
	D) Dust-tight transformers (IPX6) test according to C)		N/A
	E) Drip-proof transformers (IPX1) test according to fig. 3 of IEC 60 529 for 10 min		N/A
	F) Rain-proof transformers (IPX3) test according to fig. 4 of IEC 60 529 for 10 min in operation and 10 min switched off (the tube shall oscillate 2 x 120 °C)		N/A
	G) Splash-proof transformers (IPX4) test according to fig. 4 of IEC 60 529 (see F) for 10 min in operation and 10 min switched off (the tube shall oscillate 2 x 360 °C)		N/A
	H) Jet-proof transformer (IPX5) test according to fig. 6 of IEC 60 529		N/A
	I) Watertight transformers (IPX7)		N/A
	J) Pressure watertight transformers (IPX8)		N/A
17.2	After moisture test (48 h for ≤ IP20, 168 h for other transformers): 48 hours		P
	- insulation resistance and electric strength (Cl. 18)	Complied with requirements	P

IEC 61558-2-17			
Clause	Requirement – Test	Result - Remark	Verdict

18	INSULATION RESISTANCE AND ELECTRIC STRENGTH		P
18.2	Insulation resistance between:		P
	- live parts and body for basic insulation $\geq 2 \text{ M}\Omega$		N/A
	- live parts and body for reinforced insulation $\geq 7 \text{ M}\Omega$	>100 $\text{M}\Omega$	P
	- input circuits and output circuits for basic insulation $\geq 2 \text{ M}\Omega$		N/A
	- input circuits and output circuits for double or reinforced insulation $\geq 5 \text{ M}\Omega$	>100 $\text{M}\Omega$	P
	- each input circuit and all other input circuits connected together $\geq 2 \text{ M}\Omega$	Only one input circuit	N/A
	- each output circuit and all other output circuits connected together $\geq 2 \text{ M}\Omega$	Only one output circuit	N/A
	- hazardous live parts and metal parts with basic insulation (Class II transformers) $\geq 2 \text{ M}\Omega$	Core of transformer T1 considered as primary circuit	N/A
	- body and metal parts with basic insulation (Class II transformers) $\geq 5 \text{ M}\Omega$	Reinforced insulation	N/A
	- metal foil in contact with inner and outer surfaces of enclosures $\geq 2 \text{ M}\Omega$	> 100 M	P
18.3	Electric strength test (1 min): no flashover or breakdown:		P
	1) basic insulation between input circuits and output circuits; working voltage (V); test voltage (V)		N/A
	2) double or reinforced insulation between input circuits and output circuits; working voltage (V); test voltage (V)	Working voltage: 240 Vac Test voltage: 4200 Vac	P
	3) basic or supplementary insulation between:		P
	a) live parts of different polarity; working voltage (V); test voltage (V)	Working voltage: 240 Vac Test voltage: 2100 Vac	P
	b) live parts and the body if intended to be connected to protective earth	Class II transformer	N/A
	c) inlet bushings and cord guards and anchorages :		N/A
	d) live parts and an intermediate conductive part ... :	Core of transformer T1 considered as primary circuit	N/A
	e) intermediate conductive parts and body	Core of transformer T1 considered as primary circuit	N/A

IEC 61558-2-17			
Clause	Requirement – Test	Result - Remark	Verdict
	4) Reinforced insulation between the body and live parts; working voltage (V); test voltage (V)	Working voltage: 240 Vac Test voltage: 4200 Vac	P
18.4	This subclause does not apply (EN 61558-2-17:97)		P

19	CONSTRUCTION		P
19.1	Isolating and safety isolating transformers (EN 61558-2-17:97)		P
	Input and output circuits electrically separated (EN 61558-2-17:97)		P
	No possibility of any connection between these circuits (EN 61558-2-17:97)		P
19.1.1	The insulation between input and output winding(s) consist of double or reinforced insulation (exception see 19.1.3) (EN 61558-2-17:97)	Reinforced insulation used	P
	Class I transformers (EN 61558-2-17:97):		N/A
	- insulation between input windings and body consist of basic insulation (EN 61558-2-17:97)		N/A
	- insulation between output windings and body consist of supplementary insulation (EN 61558-2-17:97)		N/A
	Class II transformers (EN 61558-2-17:97):		P
	- insulation between input windings and body consist of double or reinforced insulation (EN 61558-2-17:97)		P
	- insulation between output windings and body consist of double or reinforced insulation (EN 61558-2-17:97)		N/A
19.1.2	Class I transformers (EN 61558-2-17:97):		N/A
	- the insulation between input and output windings via intermediate metal parts (not connected to the body) consist of double or reinforced insulation (EN 61558-2-17:97)		N/A
	Class II transformers (EN 61558-2-17:97):		P
	- the insulation between input windings and body, and between output windings and body via intermediate metal part consist of double or reinforced insulation (EN 61558-2-17:97)	Reinforced insulation used between input circuit and body; core of transformer T1 considered as primary circuit	P
	Class I and Class II transformers (EN 61558-2-17:97):		P

IEC 61558-2-17			
Clause	Requirement – Test	Result - Remark	Verdict
	- the insulation between intermediate metal part and input or output windings consist of at least basic insulation (EN 61558-2-17:97)	Core of transformer T1 considered as primary circuit; reinforced insulation used between core and output circuit	P
19.1.3	Class I transformers with protective screening (EN 61558-2-17:97):		N/A
	- insulation between input winding and protective screen consist of basic insulation (rated for the input voltage) (EN 61558-2-17:97)		N/A
	- insulation between output winding and protective screen consist of basic insulation (rated for the output voltage) (EN 61558-2-17:97)		N/A
	- the protective screen consist of metal foil or a wire wound screen extending the full width of the windings (EN 61558-2-17:97)		N/A
	- at a wire wound screen no space between the turns (EN 61558-2-17:97)		N/A
	- the cross-section of the screen is at least corresponding to the rated current of the overload device (EN 61558-2-17:97)		N/A
	- lead-out wires of the screen soldered or fixed in an equally reliable manner (EN 61558-2-17:97)		N/A
19.2	Fiercely burning material not used	No such kinds of material used	P
	Unimpregnated cotton, silk, paper and fibrous material not used as insulation		P
	Wax, impregnants, etc. not used		P
19.3	Portable transformer: short-circuit proof or fail-safe	Short-circuit proof transformer	P
19.4	Class II transformers: contact between accessible metal parts and conduits or metal sheaths of supply wiring impossible		P
19.5	Class II transformers: part of supplementary or reinforced insulation, during reassembly after routine servicing not omitted		P
19.6	Class I and II transformers: creepage distances and clearances over supplementary or reinforced insulation if wire, screw, nut, etc. become loose or fall out of position not \leq 50% specified values (Cl. 26)		N/A
19.7	Parts connected to accessible metal parts by resistors or capacitors shall be separated from hazardous live parts by double or reinforced insulation		P

IEC 61558-2-17			
Clause	Requirement – Test	Result - Remark	Verdict
19.8	Resistors or capacitors connected between hazardous live parts and accessible metal parts consist of:		P
	- at least two separate components	Only one Y1 capacitor	N/A
	- if one component is short-circuited or open circuited, values specified in Cl. 9 shall not be exceeded		N/A
	- components according to IEC 60 065, 14.1 or capacitor Y1 according to IEC 60 384-14	Only one approved Y1 capacitor between primary and secondary circuit	P
19.9	Insulation material input/output and supplementary insulation of rubber resistant to ageing	No such material used	N/A
	Creepage distances (if cracks) \geq specified values (Cl. 26)		N/A
19.10	Protection against accidental contact by insulating coating:		N/A
	a) ageing test (section I, IEC 60 068-2-2), test Ba: 168 h; 70 °C		N/A
	b) impact test (spring-operated impact hammer according to IEC 60 068-2-63; 0,5 \pm 0,05 J)		N/A
	c) scratch test (hardened steel pin) electric strength test according to Cl. 18		N/A
19.11	Handles, levers, knobs, etc.:		N/A
	- insulating material		N/A
	- supplementary insulation covering		N/A
	- separated from shafts or fixing by supplementary insulation		N/A
19.12	Windings construction		P
19.12.1	In all types of transformer, precautions shall be taken to prevent:		P
	- undue displacement of input or output windings or turns thereof	Suitable fixed by bobbin and insulating tape.	P
	- undue displacement of internal wiring or wires for external connection		P
	- undue displacement of parts of windings or of internal wiring in case of rupture or loosening		P
19.12.2	Serrated tape:		N/A
	- distance through insulation according to table 13	No serrated tape used	N/A
	- one additional layer of serrated tape, and		N/A
	- one additional layer without serration		N/A

IEC 61558-2-17			
Clause	Requirement – Test	Result - Remark	Verdict
	- in case of cheekless bobbins the end turns of each layer shall be prevented from being displaced		N/A
19.12.3	Insulated windings wires:		P
	- to all types of transformers for basic or supplementary insulation taken separately		N/A
	- transformers for switch mode power supplies for all types of insulation even in combination		N/A
	a) Winding wire with basic or supplementary insulation:		N/A
	- comply with Annex K		N/A
	- the insulation of the conductor: two layers		N/A
	b) Winding wire with double or reinforced insulation:		P
	- comply with Annex K	Approved TIW-M used as secondary winding of transformer	P
	- the insulation of the conductor: three layers		N/A
	- two adjacent insulated wires: separated by double insulation, each insulation (basic and supplementary) is rated for the working voltage of the insulation system		N/A
	c) Routine test according to Annex K.3 for windings giving double or reinforced insulation:		N/A
	- thermal cycling test according to 14.3		N/A
	- test according to 27.3		N/A
	- in table 13, table C.1 and table D.2, box 2) c), no value is required		N/A
19.13	Handles, operating levers and the like shall be fixed	No such device	N/A
19.14	Protection against electric shock: covers securely fixed, 2 independent fixing means, one with tool	Fixed by supersonic weld	P
19.15	Transformer with pins for fixed socket-outlets: no strain on socket-outlet		P
	Additional torque $\leq 0,25$ Nm	Max. 0,03 Nm	P
19.16	Protection index for portable transformers:		P
	≤ 200 VA \geq IP20 and instructions for use	Ordinary transformer and < 200 VA	P
	> 200 VA $\leq 2,5$ kVA \geq IPX4 (single-phase)		N/A
	> 200 VA $\leq 6,3$ kVA \geq IPX4 (polyphase)		N/A

IEC 61558-2-17			
Clause	Requirement – Test	Result - Remark	Verdict
	> 2,5 VA (single-phase) ≥ IP21		N/A
	> 6,3 VA (polyphase) ≥ IP21		N/A
19.17	Transformers IPX1-IPX6 totally enclosed, except for drain hole (diameter ≥ 5 mm or 20 mm ² with width ≥ 3 mm); drain hole not required for transformer completely filled with insulating materials	Ordinary transformer	N/A
	Transformers ≥ IPX7 totally enclosed		N/A
19.18	Transformers ≥ IPX1 with a moulded, if any		N/A
19.19	Class I transformers with a non-detachable flexible cable or cord with earthing conductor and a plug with earthing contact	Class II transformer	N/A
19.20	Live parts of SELV and PELV-circuits: separation not less than PRI/SEC of a safety isolating transformer	No PELV circuit	N/A
19.20.1	SELV circuits and parts not connected to earth, to live parts, or protective conductors forming part of other circuits		P
	Nominal voltage (V) > 25 V a.c. or 60 V d.c., the required insulation fulfils the high voltage test according to table 8	< 60 Vdc	N/A
19.20.2	PELV-circuits double or reinforced insulation is necessary		N/A
19.21	PELV-circuits: protection against contact fulfils the min. test voltage required for the primary circuit		N/A
19.22	Class II transformers shall not be provided with means for protective earthing		P
	For fixed transformers an earthing conductor with double or reinforced insulation to accessible metal parts is allowed	Portable transformer	N/A
19.23	Class III transformers shall not be provided with means for protective earthing	Class II	N/A
19.101	No connections between output winding and body or protective circuit, if any (EN 61558-2-17:97)		P
	For associated transformers these connections are allowed in compliance with the relevant equipment standard (EN 61558-2-17:97)	Portable transformer	N/A
19.102	Isolating and safety isolating transformers (EN 61558-2-17:97)		P
	The distance between input and output terminals for the connection of external wiring ≤ 25 mm (EN 61558-2-17:97)		N/A

IEC 61558-2-17			
Clause	Requirement – Test	Result - Remark	Verdict
20	COMPONENTS		P
20.1	Switches, plugs, fuses, lampholders, flexible cables and cords comply with relevant IEC standard	See attachable components list table	P
	Appliance couplers for main supply shall comply with:		P
	- IEC 60 320 for IPX0		P
	- IEC 60 309 for other		N/A
	Automatic controls shall comply with IEC 60 730-1		N/A
20.2	Disconnection from the supply:		N/A
	- all-poles switches with contact separation ≥ 3 mm		N/A
	- flexible cable and cord with plug		N/A
	- instruction sheet: disconnection by all-poles switches (with normal gap) incorporated in fixed wiring		N/A
20.3	Socket-outlets in the output circuit shall not comply with socket-outlets of the input circuit		N/A
	Plugs and socket-outlets for SELV for general use comply with the requirements of IEC 60 906-3		N/A
	Plugs and socket-outlets for PELV systems shall comply with:		N/A
	- plugs shall not be able to enter in socket-outlets of other standardized voltage systems		N/A
	- socket-outlets shall not admit plugs of other standardized voltage systems		N/A
	- no protective earthing contact on socket-outlets		N/A
	Plugs and socket-outlets for PELV systems shall comply with:		N/A
	- plugs shall not be able to enter in socket-outlets of other standardized voltage systems		N/A
	- socket-outlets shall not admit plugs of other standardized voltage systems		N/A
20.4	Thermal cut-outs, overload releases etc. have adequate breaking capacity	Overload protecting by internal control circuit	N/A
20.5.1	Thermal cut-out tested as component shall comply with IEC 60 730-1	No such device	N/A
20.5.2	Thermal cut-out tested as a part of the transformer, number of cycles of automatic action:		N/A
	- 3000 cycles for thermal cut-outs with self-resettable reset		N/A

IEC 61558-2-17			
Clause	Requirement – Test	Result - Remark	Verdict
	- 300 cycles for thermal cut-outs which are non-self-resettable		N/A
	- 30 cycles for thermal cut-outs which are only resettable by a tool		N/A
20.5.3	Test of a PTC resistor:	No such device	N/A
	5 cycles: transformer short-circuited for 48 h by 1,1 times of the input voltage and max. ta		N/A
	5 cycles: transformer short-circuited for 48 h by 0,9 times of the input voltage and min. ta (if declared)		N/A
20.6	Thermal-links shall comply with IEC 60 691	No such device	N/A
20.6.2	Thermal-links tested as a part of the transformer:		N/A
	- ageing test 300 h by 35 °C or ta + 10 °C		N/A
	- after opening the thermal-link shall have an insulation resistance of at least 0,2 MΩ		N/A
	- 10 cycles for replaceable thermal-links		N/A
	- 3 new specimens for not replaceable thermal-links		N/A
20.7	Self-resetting devices not used if mechanical, electrical, etc. hazards		N/A
20.8	Overload protection by thermal cut-outs which can be reset by soldering operation not allowed		N/A
20.9	Overload protection devices do not operate during test (20 times switched on and off, no load); Upri (V): 1,06 times rated supply voltage		P

21	INTERNAL WIRING		P
21.1	Internal wiring and electrical connections protected or enclosed		P
	Wireways smooth and free from sharp edges		P
21.2	Openings in sheet metal: edges rounded (radius ≥ 1,5 mm) or bushings of insulating material	Plastic enclosure used	N/A
21.3	Bare conductors: distances adequately maintained		P
21.4	When external wires are connected to terminal, internal wiring shall not work loose		P
21.5	Insulation of heat-resistant and non-hygroscopic material for insulated conductors subject to temperature rise > limiting values given in 14.2		N/A

IEC 61558-2-17			
Clause	Requirement – Test	Result - Remark	Verdict

22	SUPPLY CONNECTION AND EXTERNAL FLEXIBLE CABLES AND CORDS		P
22.1	All cables, flexible cords etc. shall have appropriate current and voltage ratings		P
22.2	Input and output wiring inlet and outlet openings for external wiring: separate entries without damage to protective covering of cable or cord	Only for output cord	P
	Input and output wiring inlet and outlet openings for flexible cables or cords: insulating material or bushing of insulating material	Insulating material for output bushing	P
	Bushings for external wiring: reliably fixed, not of rubber unless part of cord guard		P
22.3	Fixed transformer:		N/A
	- possible to connect after fixing		N/A
	- inside space for wires allow easy introduction and connection of conductors		N/A
	- fitting of cover without damage to conductors		N/A
	- contact between insulation of external supply wires and live parts of different polarity not allowed		N/A
22.4	Length of power supply cord for portable transformers between 2 m and 4 m; without 0,5 mm	Direct plug-in input, no power supply cord	N/A
22.5	Power supply cords:		N/A
	- for transformers IPX0 for indoor use only code designation 53 of IEC 60 245-1 or code designation 53 of IEC 60 227-1		N/A
	- for transformers IPX0 for outdoor use: H05 RN...		N/A
22.6	Power supply cords for single-phase portable transformers with input current ≤ 16 A:		N/A
	- cord set fitted with an appliance coupler in accordance with IEC 60 320		N/A
22.7	Nominal cross-sectional area (mm ²); input current (A) at rated output not less than shown in table 9 . :		N/A
22.8	Class I transformer with power supply flexible cable: green/yellow core connected to earthing terminal		N/A
	Plug for single-phase transformer with input current at rated output ≤ 16 A according to IEC 60 083, IEC 60 906-1 or IEC 60 309		N/A
22.9	Type X, Y, or Z attachments: see relevant Part 2	For output cord	P

IEC 61558-2-17			
Clause	Requirement – Test	Result - Remark	Verdict
22.9.1	For type Z attachment: moulding enclosure and power supply cable do not affect insulation of cable		P
22.9.2	Inlet openings or inlet bushing: without risk of damage to protective covering of power supply cord		P
	Insulation between conductor and enclosure:		P
	- for Class I transformer: insulation of conductor plus separate basic insulation		N/A
	- for Class II transformer: insulation of conductor plus double or reinforced insulation		P
22.9.3	Inlet bushings:		N/A
	- no damage to power supply cord		N/A
	- reliably fixed		N/A
	- not removable without tool		N/A
	- not integral with power supply cord (for type X attachment)		N/A
	- not of natural rubber except for Class I transformer with type X, Y and Z attachments		N/A
22.9.4	For portable transformers which are moved while operating:		N/A
	- cord guards, if any, of insulating material and fixed		N/A
	Compliance is tested by the oscillating test according to fig. 7:		N/A
	- loaded force during the test according to fig. 7		N/A
	- 10 N for a cross-sectional area > 0,75		N/A
	- 5 N for a cross-sectional area ≤ 0,75		N/A
	After the test according to fig. 7:		N/A
	- no short-circuit between the conductors		N/A
	- no breakage of more than 10% of strands of any conductor		N/A
	- no separation of the conductor from the terminal		N/A
	- no loosening of any cord guards		N/A
	- no damage of the cord or cord guard		N/A
	- no broken strands piercing the insulation and not becoming accessible		N/A
22.9.5	Cord anchorages for type X attachment:		N/A
	- glands in portable transformers not used unless possibility for clamping all types and sizes of cable		N/A

IEC 61558-2-17			
Clause	Requirement – Test	Result - Remark	Verdict
	- moulded-on designs, tying the cable into a knot and tying the end with string not allowed		N/A
	- labyrinths, if clearly how, permitted		N/A
	- replacement of cable easily possible		N/A
	- protection against strain and twisting clearly how		N/A
	- suitable for different types of cable unless only one type of cable for transformer		N/A
	- the whole flexible cable or cord with covering can be mounted into the cord anchorage		N/A
	- if tightened or loosened no damage		N/A
	- no contact between cable or cord and accessible or electrically connected clamping screws		N/A
	- cord clamped by metal screw not allowed		N/A
	- one part securely fixed to transformer		N/A
	- screws do not serve to fix any other component unless if omitted or incorrectly mounted the transformer is inoperative or clearly incomplete; compliance or parts not removable without tool		N/A
	- for Class I transformer: insulating material or insulated from metal parts		N/A
	- for Class II transformers: insulating material or supplementary insulation from metal parts		N/A
	Cord anchorages for type X, Y, Z attachments: cores of external flexible cable or cord insulated from accessible metal parts by:		N/A
	- basic insulation (Class I transformers), separate insulating barrier/cord anchorage		N/A
	- supplementary insulation (Class II transformers), special lining/cable or cord sheath of cable sheath of cable		N/A
	Cord anchorages for type X and Y attachments:		N/A
	- replacement of external flexible cable or cord does not impair compliance with standard		N/A
	- the whole flexible cable or cord with covering can be mounted into the cord anchorage		N/A
	- if tightened or loosened no damage		N/A
	- no contact between cable or cord and accessible or electrically connected clamping screws		N/A
	- cord clamped by metal screws not allowed		N/A
	- knots in cord not used		N/A

IEC 61558-2-17			
Clause	Requirement – Test	Result - Remark	Verdict
	- labyrinths, if clearly how, permitted		N/A
	Tests for type X with special cords, type Y, type Z	Type Z attachment for output cord	P
	Test for type X attachments one test with a cord with smallest and one test with a cord with the largest cross-sectional area:		N/A
	- for the test with clamping screws or tightened with torque 2/3 of that specified in table 11		N/A
	- not possible to push cable into transformer		P
	- 25 pulls of 1 s		P
	- 1 min torque according to table 10		P
	- mass (kg); pull (N); torque (Nm) : 0,08 Kg , 30 N, 0,1 Nm		—
	- not possible to push cable into transformer		P
	- during test: cable not damaged		P
	- after test: longitudinal displacement ≤ 2 mm for cable or cord and ≤ 1 mm for conductors in terminals	Longitudinal displacement: 0,3 mm for cord and 0,2 mm for conductor	P
	- creepage distances and clearances ≥ values specified in Cl. 26 :		P
22.9.6	Space for supply cables or external flexible cable or cord for fixed wiring and for type X, and Y attachments:		N/A
	- before fitting cover, possibility to check correct connection and position of conductors		N/A
	- cover fitted without damage to supply cords		N/A
	- for portable transformers: contact with accessible metal parts if conductor becomes loose not allowed unless for type X, Y attachments terminations of cords do not slip free of conductor		N/A
	Space for external cords or cable for type X attachment and for connection to fixed wiring, in addition:		N/A
	- conductor easily introduced and connected		N/A
	- possibility of access to terminal for external conductor after removal of covers without special purpose tool		N/A

23	TERMINALS FOR EXTERNAL CONDUCTORS		P
23.1	Transformer for connection to fixed wiring and transformer without power supply cords with type Y and Z attachments: only connections by screws, nuts terminals		N/A

IEC 61558-2-17			
Clause	Requirement – Test	Result - Remark	Verdict
	Terminals are integral part of the transformer:		N/A
	- comply with IEC 60 999-1 under transformer conditions		N/A
	Other terminals:		N/A
	- separately checked according to IEC 60 998-2-1, IEC 60 998-2-2 or IEC 60 947-7-1		N/A
	- used in accordance with their marking		N/A
	- checked according to IEC 60 999-1 under transformer conditions		N/A
	Transformer with type X attachments: soldered connection permitted if reliance not placed upon soldering, crimping or welding alone unless by barriers, creepage distances and clearances between hazardous live parts and metal parts should conductor break away $\geq 50\%$ of specified value (Cl. 26)		N/A
	Transformer with type Y and Z attachments for external conductors: soldered, welded, crimped, etc. connections allowed		P
	For Class II transformer: reliance not placed upon soldering, crimping or welding alone unless by barriers, creepage distances and clearances between hazardous live parts and metal parts should conductor break away $\geq 50\%$ of specified value (Cl. 26)		P
23.2	Terminals for type X with special cords Y and Z attachments shall be suitable for their purpose:		P
	- test by inspection according to 23.1 and 23.2		P
	- pull of 5 N to the connection before test according to 14.2		P
23.3	Other terminals than Y and Z attachments shall be so fixed that when the clamping means is tightened or loosened:		N/A
	- terminal does not work loose		N/A
	- internal wiring is not subjected to stress		N/A
	- creepage distances and clearance are not reduced below the values specified in Cl. 26		N/A
23.4	Other terminals than Y and Z attachments shall be so designed that:		N/A
	- they clamp the conductor between metallic surfaces with sufficient contact pressure		N/A
	- without damage to the conductor		N/A
	- test by inspection according to 23.3 and 23.4		N/A

IEC 61558-2-17			
Clause	Requirement – Test	Result - Remark	Verdict
	- 10 times fastening and loosening a conductor with the largest cross-sectional area with 2/3 of the torque specified in Cl. 25		N/A
23.5	Terminals for fixed wiring and for type X: located near their associated terminals of different polarities and the earthing terminal if any		N/A
23.6	Terminal blocks not accessible without the aid of a tool		N/A
23.7	Transformer with type X attachments: stranded conductor test (8 mm removed):		N/A
	- Class I transformers: no connection between live parts and accessible metal parts		N/A
	- free wire of earthing terminal: no touching of live parts		N/A
	- Class II transformers: no connection between live parts and accessible metal parts, no connection between live parts and metal parts separated from accessible metal parts by supplementary insulation		N/A
	Terminals for a current > 25 A:		N/A
	- pressure plate, or		N/A
	- two clamping screws		N/A
23.8	When terminal, other than protective earthing conductor, screws loosened as far as possible, no contact:		N/A
	- between terminal screws and accessible metal parts		N/A
	- between terminal screws and accessible metal parts for Class II transformers		N/A

24	PROVISION FOR PROTECTIVE EARTHING		N/A
24.1	Class I transformers: accessible parts connected to earthing terminal		N/A
	Class II transformers: no provision for earthing		N/A
24.2	Protective earthing terminal for connection to fixed wiring and for type X attachment transformers: comply with Cl. 23, adequately locked, not possible to loosen without a tool		N/A
24.3	No risk of corrosion from contact between metal of earthing terminal and other terminal		N/A
	In case of earthing terminal body of A1, no risk of corrosion from contact between Cu and A1		N/A

IEC 61558-2-17			
Clause	Requirement – Test	Result - Remark	Verdict
	Body of earthing terminal or screws/nuts of brass or other metal resistant to corrosion		N/A
24.4	Resistance of connection between earthing terminal and metal parts $\leq 0,1 \Omega$ with a min. 25 A or 1,5 times rated input current at 1 min		N/A
24.5	Class I transformers with external flexible cables or cords:		N/A
	- current-carrying conductors becoming taut before the earthing conductor		N/A

25	SCREWS AND CONNECTIONS		N/A
25.1	Screwed connections withstand mechanical stresses	Only one screw used to fixed EU plug pin to enclosure	N/A
	Screws transmitting contact pressure or likely to be tightened by the user or having a diameter < 2,8 mm, shall screw into metal		N/A
	Screws not of metal which is soft or liable to creep (Zn, Al)		N/A
	Screws of insulating material: not used for electrical connection		N/A
	Screws not of insulating material if their replacement by metal screws can impair supplementary or reinforced insulation		N/A
	Screws to be removed (replacement etc. of power supply cord) not of insulating material if their replacement by metal screws can impair basic insulation		N/A
	No damage after torque test: diameter (mm); torque (Nm); ten times		N/A
	No damage after torque test: diameter (mm); torque (Nm); five times		N/A
25.2	Screws in engagement with thread of insulating material:		N/A
	- length of engagement $\geq 3 \text{ mm} + 1/2$ screw diameter or 8 mm		N/A
	- correct introduction into screw hole		N/A
25.3	Electrical connections: contact pressure not transmitted through insulating material		N/A
25.4	In case of use of thread-forming (sheet metal) screws for connection of current-carrying parts: clamping and locking means provided		N/A

IEC 61558-2-17			
Clause	Requirement – Test	Result - Remark	Verdict
	Thread-cutting (self-tapping) screws used for the connection of current-carrying parts allowed if they generate a full form machine screw thread and if not operated by the user		N/A
	Thread-cutting screws and thread-forming screws used for earthing continuity allowed if at least 2 screws for each connection are used and it is not necessary to disturb the connection in normal use		N/A
25.5	Screws for current-carrying mechanical connections locked against loosening		N/A
	Rivets for current-carrying connections subject to torsion locked against loosening		N/A

26	CREEPAGE DISTANCES AND CLEARANCES		P
26.1	Specified values according to:		P
	- table 13, material group IIIa		P
	- table C, material group II		N/A
	- table D, material group I		N/A
	1. Insulation between input and output circuits (basic insulation):		N/A
	a) measured values \geq specified values (mm)		N/A
	2. Insulation between input and output circuits (double or reinforced insulation):		P
	a) measured values \geq specified values (mm)	Working voltage: 240 Vac Transformer secondary winding used triple insulation wire. Between primary trace and secondary trace on PCB: CI = 5,6 > 4,6 mm, Cr = 7,2 > 4,8 mm	P
	b) measured values \geq specified values (mm)		N/A
	c) measured values \geq specified values (mm)		N/A
	3. Insulation between adjacent input circuits: measured values \geq specified values (mm)		N/A
	Insulation between adjacent output circuits: measured values \geq specified values (mm)		N/A
	4. Insulation between terminals for external connection:		N/A
	a) measured values \geq specified values (mm)		N/A
	b) measured values \geq specified values (mm)		N/A

IEC 61558-2-17			
Clause	Requirement – Test	Result - Remark	Verdict
	c) measured values \geq specified values (mm)		N/A
	5. Basic or supplementary insulation:		P
	a) measured values \geq specified values (mm)	Working voltage: 240 Vac Between Line and Neutral before fuse F1: Cl = 6,3 > 2,4; Cr=6,6 > 2,5 mm	P
	b) measured values \geq specified values (mm)		N/A
	c) measured values \geq specified values (mm)		N/A
	d) measured values \geq specified values (mm)	Transformer core of T1 considered as primary circuits	N/A
	e) measured values \geq specified values (mm)	Transformer core of T1 considered as primary circuits	N/A
	6. Reinforced or double insulation: measured values \geq specified values (mm)	Working voltage: 240 Vac Between live part to enclosure: Cl = 5,6 > 4,6 mm, Cr = 5,6 > 4,8 mm	P
	7. Distance through insulation:		P
	a) measured values \geq specified values (mm)	2 layers insulation tape used to wrap the core of the transformer.	N/A
	b) measured values \geq specified values (mm)		N/A
	c) measured values \geq specified values (mm)	Working voltage: 240 Vac Enclosure thickness: Min. 2,0 mm > 1,0 mm	P
	Creepage distances and clearances are measured:		N/A
	- for fixed wiring and type X attachments with max. and min. size		N/A
	- for type X with a special cord, Y or Z attachments with the supply cable as delivered		N/A
	- for layers of serrated tapes the values are so determined as if the serration coincided through the different layers		N/A
	- for printed wiring shall be used the unreduced values for live parts as in table 13, C.1 or D.1, except if printed wiring complies with IEC 60 664-3		N/A
	If the pollution generates high and persistent conductivity caused, for instance, by conductive dust or by rain or snow:		N/A
	- clearances of P3 increased with min. 1,6 mm		N/A
	- value X in Annex A increased with 4,0 mm		N/A

IEC 61558-2-17			
Clause	Requirement – Test	Result - Remark	Verdict
26.2	Creepage distances (cr)		N/A
	A) To test the potting or impregnation, three transformers are used:		N/A
	- thermal class		N/A
	- working voltage		N/A
	Test with three transformers		N/A
	Two of the three specimens are subjected to:		N/A
	- the relevant humidity treatment according to 17.2 (48 h)		N/A
	- the relevant dielectric strength test of 18.3 multiplied with factor 1,25		N/A
	One of the three specimens is subjected to the relevant dielectric strength test of 18.3 multiplied by the factor 1,25 immediately at the end of the last cycle with high temperature		N/A
	Impulse dielectric test according to 4.1.1.2.1 of IEC 60 664-1 (1,2 / 50 µs waveform)		N/A
	Impulse test voltage		N/A
	Requirements of reduced values as stated for pollution degree 1 (P1) are fulfilled (see 26.1)		N/A
	B) To test parts which are connected (stuck) together:		N/A
	- thermal class		N/A
	- working voltage		N/A
	Test with three specially prepared specimens		N/A
	Two of the three specimens are subjected to:		N/A
	- the humidity treatment according to 17.2 (48 h)		N/A
	- the relevant dielectric strength test of 18.3 multiplied with factor 1,6		N/A
	One of the three specimens is subjected to the relevant dielectric strength test of 18.3 multiplied by the factor 1,6 immediately at the end of the last cycle with high temperature		N/A
	Impulse dielectric test according to 4.1.1.2.1 of IEC 60 664-1 (1,2 / 50 µs waveform)		N/A
	Impulse test voltage		N/A
	Requirements of reduced values as stated for pollution degree 1 (P1) are fulfilled (see 26.1)		N/A
26.3	Insulation in thin sheet form:		P

IEC 61558-2-17			
Clause	Requirement – Test	Result - Remark	Verdict
	- consist of at least three layers (separable or non-separable)		P
	- fulfils the requirements of distance through insulation shown in square brackets in boxes 2 and 7 of table 13 (C.1 / D.1)		P
	- separate or separable layers fulfil the thermal classification according to IEC 60 085 and IEC 60 216 for each layer		P
	- non-separable layers fulfil the thermal classification of the transformer in the whole composite sheet		N/A
	Mandrel test of insulation in thin sheet form:		N/A
	- with two thirds of the number of separate or separable layers in any combination, high voltage test: 5,5 kV one minute, no flashover or breakdown		N/A
	- with the whole composite sheet of non-separable layers, high voltage test: 5,5 kV one minute, no flashover or breakdown		N/A
	- with one of the two layers according to note 6 of table 13 (C.1/D.1) without requirements of thickness, high voltage test: 5,5 kV one minute, no flashover or breakdown		N/A
	The figures within square brackets in boxes 2 and 7 of table 13 (C.1/D.1) are used for insulation in thin sheet form as follows:		N/A
	- rated output > 100 VA values in square brackets apply		N/A
	- rated output $\geq 25 \text{ VA} \leq 100 \text{ VA}$ 2/3 of the value in square brackets apply		N/A
	- rated output < 25 VA 1/3 of the values in square brackets apply		N/A
	- test according to 14.3 if smaller distances through insulation are used		N/A
	Solid insulation consist of a thickness of:		N/A
	- solid insulation only		N/A
	- or solid insulation plus one or more air layers (min. 2 layers of insulation)		N/A
	Reduced values of table 13 (C.1/D.1) may be used for serrated tape if:		N/A
	- min. 4 layers serrated tape		N/A
	- and one additional layer without serration covering the location of the serration		N/A

IEC 61558-2-17			
Clause	Requirement – Test	Result - Remark	Verdict
26.101	If the frequencies are ≤ 40 kHz table 13, C.1 and D.1 are applicable (EN 61558-2-17:97)		N/A
26.102	If the frequencies are > 40 kHz the values of table 13, C.1 and D.1 are used with a multiplying factor of 1,1 (EN 61558-2-17:97)	Have considered	P
	Box 2 of table 13, C.1 and D.1 is not applicable for separating transformers (EN 61558-2-17:97)	Portable transformer	N/A
	Box 1 of table 13, C.1 and D.1 is not applicable for isolating and safety isolating transformers (EN 61558-2-17:97)		P
26.103	If the transformers fulfil the requirements according to 14.3 and 26.2 (no mechanical stress) the following distances through insulation can be used (EN 61558-2-17:97):		N/A
	- working voltages ≤ 50 V a.c. (71 V peak or d.c.) no thickness (EN 61558-2-17:97)		N/A
	- supplementary insulation thickness ≤ 0,4 mm (EN 61558-2-17:97)		N/A
	- reinforced insulation with working voltage ≤ 600 V: thickness ≤ 0,4 mm (EN 61558-2-17:97)		N/A
	- supplementary insulation in thin sheet form at least two layers (EN 61558-2-17:97)	Two layers insulation tape wrapped transformer core of T1	P
	- one layer will pass the electric strength test (see also 26.3 mandrel test) (EN 61558-2-17:97)		P
	- reinforced insulation in thin sheet at least three layers (EN 61558-2-17:97)		N/A
	- any two layers will pass the electric strength test (see also 26.3 mandrel test) (EN 61558-2-17:97)		N/A

27	RESISTANCE TO HEAT, ABNORMAL HEAT, FIRE AND TRACKING		P
27.1	Ball-pressure test: diameter of impression ≤ 2 mm; heating cabinet temperature (°C)	For enclosure: 70 °C, 0,8 mm	P
27.2	Glow-wire test (650 °C):	For enclosure: 650 °C	P
	- any flame or glowing of the specimen extinguish within 30 s of withdrawing the glow-wire		P
	- no ignition of a single layer of tissue paper		P
27.3	Insulating material retaining live parts in position of transformers ≥ IP20: no source of ignition for surroundings in case of abnormal heat or fire	Ordinary transformer	N/A
	Two special prepared specimens for the test in which short-circuit windings are built-in		N/A

IEC 61558-2-17			
Clause	Requirement – Test	Result - Remark	Verdict
27.3.1	Portable transformers are placed on a dull painted plywood support		N/A
	Stationary transformers fixed in the most unfavourable position on a dull painted support:		N/A
	- if this position for use is vertical or ceiling transformer and support 200 mm above a pinewood board with tissue paper		N/A
	Self-resettable devices are short-circuit		N/A
	Input circuits protected with 10 times rated current, min. 16 A (fuse)		N/A
	Test time for protective devices of the transformer without load:		N/A
	- max. 15 days, or		N/A
	- definitive interruption in the input circuit		N/A
	If non-self-resettable or replaceable protective devices are used the following cycle test is necessary:		N/A
	- non-self-resettable: 30 cycles with no load until interruption and 2 h cool down		N/A
	- replaceable protective device: 10 cycles with no load until interruption and 2 h cool down		N/A
	During the tests:		N/A
	- no flames occur		N/A
	-support temperature shall not exceed 125 °C		N/A
	- no ignition of the tissue paper		N/A
27.3.2	After the tests:		N/A
	a) transformer with definitive interruption in the input circuit withstands the test with 35% of the values according to table 8		N/A
	b) transformer with no definitive interruption withstands the test voltage (100%) according to table 8 of Cl. 18: hazardous live parts are not touchable by the stranded test finger		N/A
27.4	Insulating material retaining live parts in position: resistant to abnormal heat and to fire		P
	Ball-pressure test; test temperature (°C)	For PCB: 125°C, 0,9 mm For EU and UK pin sleeving: 125°C, 1,0 mm and 1,1 mm For bobbin: 125°C, 0,8 mm	P
	Glow-wire test (850 °C) for insulating material retaining external conductor terminals (if > 0,5 A):		P

IEC 61558-2-17			
Clause	Requirement – Test	Result - Remark	Verdict
	- any flame or glowing of the specimen extinguish within 30 s of withdrawing the glow-wire		N/A
	- no ignition of a single layer of tissue paper		N/A
27.5	For IP other than IPX0: insulating parts retaining live parts in position of material resistant to tracking at least material of group IIIa	Ordinary transformer	N/A
	Test (175 V): no flashover or breakdown before 50 drops		N/A

28	RESISTANCE TO RUSTING		P
	Ferrous parts protected against rusting		P

F	ANNEX F, REQUIREMENTS FOR SWITCHES COMPLYING WITH IEC 61058		N/A
F.1	a) Manually operated mechanical switches shall comply with IEC 61058 with the conditions specified under F.1 a) and F.5		N/A
	b) Manually operated mechanical switches tested as part of the apparatus shall comply with the conditions specified under F.2, F.3, F.4 and F.5		N/A

H	ANNEX H, ELECTRONIC CIRCUITS		P
H.15	Short-circuit and overload protection		P
H.15.6	Circuits designed and applied so that fault conditions do not render the appliance unsafe		P
	During and after each test:		P
	- temperatures do not exceed values specified in table 3 of Cl. 15		P
	- transformer complies with conditions specified in 15.1		P
	If a conductor of a pcb becomes open circuited, the transformer is considered to have withstood the particular test, provided that all six conditions as specified are met		P
H.15.7	Fault conditions a) to f) of B.15.8 are not tested if the following conditions are met:		N/A
	- electronic circuit is a low-power circuit as specified		N/A
	- safety of the appliance as specified does not rely on correct functioning of the electronic circuit		N/A

IEC 61558-2-17			
Clause	Requirement – Test	Result - Remark	Verdict
H.15.8	Fault conditions tested as specified when relevant:		P
	a) short-circuit of creepage distances and clearances, if less than specified in Cl. 26		N/A
	b) open circuit at the terminals of any component	See appended table	P
	- short-circuit of capacitors, unless they comply with IEC 60 384-14	See appended table	P
	d) short-circuit of any two terminals of an electronic component as specified	See appended table	P
	e) any failure of an integrated circuit as specified	See appended table	P
	f) low-power circuit: low-power points are connected to the supply source		N/A
	Cl. 15 is repeated with a simulated fault as indicated in a) to e), if the transformer incorporates an electronic circuit to ensure compliance with Cl. 15		P
	Fault condition e) is applied for encapsulated and similar components	No encapsulated and similar component used	N/A
	PTC's and NTC's are not short-circuited if they are used as specified	No PTC used	N/A
H.15.9	If for a fuse-link complying with IEC 60 127-3 rated fuse current I1 is used, current I2 is measured as specified:		P
	- if $I2 < 2,1 \times I1$ test of 15.8 is repeated with fuse-link short-circuited		N/A
	- if $I2 > 2,75 \times I1$, no other tests are necessary		P
	If $I2 > 2,1 \times I1$ and $I2 < 2,75 \times I1$ test of 15.8 is repeated as specified		N/A
	For fuses other than those complying with IEC 60 127-3, the test is carried out as specified 15.3.2 to 15.3.5		N/A
H.26	CREEPAGE DISTANCES, CLEARANCES AND DISTANCES THROUGH INSULATION		P
H.26.1	For conductive pattern's on pcb's, except their edges, creepage distances between different polarity may be reduced as specified		N/A
	For peak voltages > 50 V reduced creepage distances only apply if proof tracking index (PTI) has a resistance to tracking corresponding to at least material group IIIa		N/A
	The distances may be further reduced as specified (see H.15)		N/A

IEC 61558-2-17			
Clause	Requirement – Test	Result - Remark	Verdict
	Creepage distances and clearances within optocouplers are not measured as specified		N/A
H.26.2	For optocouplers the conditioning procedure of 26.2 is carried out as specified	For optocoupler	P

K	ANNEX K, INSULATED WINDING WIRES FOR USE AS MULTIPLE LAYER INSULATION		N/A
K.1	Wire construction:		N/A
	- insulated winding wire with min. two layers for basic or supplementary insulation		N/A
	- insulated winding wire with min. three layers for reinforced insulation		N/A
	- winding insulation material		N/A
K.2	Conformance test		N/A
K.2.1	Test 13 of IEC 60 851-5 nominal conductor diameter $\geq 0,018 \text{ mm} \leq 0,1 \text{ mm}$		N/A
	Test as specified in 4.2.1 and 4.2.2 of IEC 60 851-5		N/A
	Nominal conductor diameter $> 0,1 \text{ mm}, \leq 2,5 \text{ mm}$, test as specified in 4.3.1 and 4.3.2 of IEC 60 851-5		N/A
	Nominal conductor diameter $< 2,5 \text{ mm}$, test as specified in 4.4.1 and 4.4.2 of IEC 60 851-5		N/A
	High voltage test immediately after the above specified tests:		N/A
	- test voltage for two layers 3 kV		N/A
	- test voltage for three layers 5,5 kV		N/A
K.2.2	Adherence and flexibility, test as specified under 5.1.4 of IEC 60 851-3		N/A
	- high voltage test immediately after this test		N/A
	- test voltage for two layers 3 kV		N/A
	- test voltage for three layers 5,5 kV		N/A
K.2.3	Heat shock, test as specified under 3.1 or 3.2 of IEC 60 851-6:		N/A
	- high voltage test immediately after this test		N/A
	- test voltage for two layers 3 kV		N/A
	- test voltage for three layers 5,5 kV		N/A
K.2.4	Retention of dielectric strength after bending, test as specified under test 13 of 4.6.1 c) of IEC 60 851-5		N/A
	- high voltage test immediately after this test		N/A

IEC 61558-2-17			
Clause	Requirement – Test	Result - Remark	Verdict
	- test voltage for two layers 3 kV		N/A
	- test voltage for three layers 5,5 kV		N/A

11 and 12		TABLE: OUTPUT VOLTAGE AND OUTPUT CURRENT UNDER LOAD; NO-LOAD OUTPUT VOLTAGE					
Clause		11		12		further information (input / Cl. 11 limit / Cl. 12 limit)	
type/rated output	rated voltage (V)	sec. voltage (V)	delta Usec (%)	Usec V no-load output	delta Usec no-load output %		
Model A / 3,6 W	2,4	2,44	1,7	2,65	8,6	100Vac 50Hz / 10% / 100%	
Model A / 3,6 W	2,4	2,44	1,7	2,65	8,6	100Vac 60Hz / 10% / 100%	
Model A / 3,6 W	2,4	2,44	1,7	2,65	8,6	240Vac 50Hz / 10% / 100%	
Model A / 3,6 W	2,4	2,44	1,7	2,65	8,6	240Vac 60Hz / 10% / 100%	
Model B / 8,5 W	10	9,78	2,2	9,95	1,7	100Vac 50Hz / 10% / 100%	
Model B / 8,5 W	10	9,78	2,2	9,95	1,7	100Vac 60Hz / 10% / 100%	
Model B / 8,5 W	10	9,78	2,2	9,95	1,7	240Vac 50Hz / 10% / 100%	
Model B / 8,5 W	10	9,79	2,1	9,95	1,6	240Vac 60Hz / 10% / 100%	
Model C / 2,41 W	24,1	24,02	0,03	24,05	0,01	100Vac 50Hz / 10% / 100%	
Model C / 2,41 W	24,1	24,02	0,03	24,05	0,01	100Vac 60Hz / 10% / 100%	
Model C / 2,41 W	24,1	24,02	0,03	24,05	0,01	240Vac 50Hz / 10% / 100%	
Model C / 2,41 W	24,1	24,02	0,03	24,05	0,01	240Vac 60Hz / 10% / 100%	
Model D / 8,4 W	24	23,94	0,03	24,03	0,04	100Vac 50Hz / 10% / 100%	
Model D / 8,4 W	24	23,94	0,03	24,03	0,04	100Vac 60Hz / 10% / 100%	
Model D / 8,4 W	24	23,94	0,03	24,03	0,04	240Vac 50Hz / 10% / 100%	
Model D / 8,4 W	24	23,94	0,03	24,03	0,04	240Vac 60Hz / 10% / 100%	

Remark: Model A = LGSPSA024150zz, Model B = LGSPSA100085zz, Model C = LGSPSA241010zz, Model D = LGSPSA240035zz

14	Heating (model LGSPSA024150zz)		P
Test Voltage: <u>90</u> V <u>50/60</u> Hz Input Power: <u>5,77</u> / <u>5,81</u> W ,			
Input Current: <u>104</u> / <u>110</u> mA , Output Current: <u>1500</u> mA.			
Ambient temperature: 27,8°C			
Monitored point:	90V 50Hz T (°C)	90V 60Hz T (°C)	Required T (°C)

IEC 61558-2-17						
Clause	Requirement – Test	Result - Remark			Verdict	
		Correct to 40°C	Correct to 40°C			
1	Transformer winding 1 (T1)	67,2	67,2		120 (B)	
2	Transformer winding 2 (T1)	68,8	68,7		120 (B)	
3	Transformer core	63,0	63,0		For reference	
4	Internal wire (AC lead wire)	53,2	53,3		80	
5	Output cord (inside enclosure)	56,2	56,5		80	
6	Enclosure (inside, near transformer)	58,0	58,0		For reference	
7	E-cap surface (EC2)	63,2	63,3		105	
8	Optocoupler (U2)	54,0	54,0		100	
9	Y-Cap (CY1)	57,1	57,2		125	
10	PCB (Top side, near U1 and transformer)	69,8	69,7		130	
11	PCB (Bottom side, under transformer)	63,6	63,7		130	
12	IC Surface (U1)	66,7	66,8		For reference	
13	Rectifying diode (D8)	75,9	76,0		For reference	
14	Enclosure surface (top)	47,6	47,5		80	
15	Supports (enclosure, near the AC plug)	43,8	44,0		85	
Temperature rise of winding:		R1(Ω)	R ₁ ()	T (°C)	Required T(°C)	Insulation class
Primary Winding		---	---	---	---	B
Secondary Winding		---	---	---	---	B
Remark: as requirement by the applicant, 0,9 and 1,1 times of input voltage and 40°C ambient condition have been considered, the test results have been calibrated to ambient 40°C.						

14	Heating (model LGSPSA024150zz)			P
Test Voltage: <u>264</u> V <u>50/60</u> Hz Input Power: <u>5,91</u> / <u>5,78</u> W ,				
Input Current: <u>124</u> / <u>123</u> mA , Output Current: <u>1500</u> mA.				
Ambient temperature: 27,8 °C				
Monitored point:		264V 50Hz T (°C)	264V 60Hz T (°C)	Required T (°C)
		Correct to 40°C	Correct to 40°C	
1	Transformer winding 1 (T1)	70,5	70,4	120 (B)

IEC 61558-2-17						
Clause	Requirement – Test	Result - Remark			Verdict	
2	Transformer winding 2 (T1)	71,5	71,3		120 (B)	
3	Transformer core	65,8	65,7		For reference	
4	Internal wire (AC lead wire)	56,0	56,0		80	
5	Output cord (inside enclosure)	58,2	58,0		80	
6	Enclosure (inside, near transformer)	60,1	59,8		For reference	
7	E-cap surface (EC2)	65,5	65,2		105	
8	Optocoupler (U2)	56,3	56,2		100	
9	Y-Cap (CY1)	59,9	59,9		125	
10	PCB (Top side, near U1 and transformer)	74,6	74,9		130	
11	PCB (Bottom side, under transformer)	66,8	66,7		130	
12	IC Surface (U1)	71,9	71,9		For reference	
13	Rectifying diode (D8)	77,7	77,5		For reference	
14	Enclosure surface (top)	48,8	58,6		80	
15	Supports (enclosure, near the AC plug)	47,8	47,6		85	
Temperature rise of winding:		R1(Ω)	R ₁ ()	T (°C)	Required T(°C)	Insulation class
Primary Winding		---	---	---	---	B
Secondary Winding		---	---	---	---	B
Remark: as requirement by the applicant, 0,9 and 1,1 times of input voltage and 40°C ambient condition have been considered, the test results have been calibrated to ambient 40°C.						

14	Heating (model LGSPSA100085)			P
Test Voltage: <u>90</u> V <u>50/60</u> Hz Input Power: <u>10,67</u> / <u>10,69</u> W ,				
Input Current: <u>189</u> / <u>201</u> mA, Output Current: <u>850</u> mA.				
Ambient temperature: 28,0°C				
Monitored point:		90V 50Hz T (°C)	90V 60Hz T (°C)	Required T (°C)
		Correct to 40°C	Correct to 40°C	
1	Transformer winding 1 (T1)	83,2	83,1	120 (B)
2	Transformer winding 2 (T1)	83,4	83,3	120 (B)
3	Transformer core	80,4	80,3	For reference

IEC 61558-2-17						
Clause	Requirement – Test	Result - Remark			Verdict	
4	Internal wire (AC lead wire)	71,3	71,1		80	
5	Output cord (inside enclosure)	64,0	64,2		80	
6	Enclosure (inside, near transformer)	62,5	62,6		For reference	
7	E-cap surface (EC2)	72,9	72,6		105	
8	Optocoupler (U2)	68,0	68,0		100	
9	Y-Cap (CY1)	73,4	73,4		125	
10	PCB (Top side, near U1 and transformer)	94,5	93,6		130	
11	PCB (Bottom side, under transformer)	77,8	77,5		130	
12	IC Surface (U1)	85,2	84,8		For reference	
13	Rectifying diode (D8)	84,4	84,6		For reference	
14	Enclosure surface (top)	51,1	51,6		80	
15	Supports (enclosure, near the AC plug)	43,7	44,1		85	
Temperature rise of winding:		R1(Ω)	R ₁ ()	T (°C)	Required T(°C)	Insulation class
Primary Winding		---	---	---	---	B
Secondary Winding		---	---	---	---	B
Remark: as requirement by the applicant, 0,9 and 1,1 times of input voltage and 40°C ambient condition have been considered, the test results have been calibrated to ambient 40°C.						

14	Heating (model LGSPSA100085zz)			P
Test Voltage: <u>264</u> V <u>50/60</u> Hz Input Power: <u>10,27</u> / <u>10,25</u> W ,				
Input Current: <u>84</u> / <u>82</u> mA , Output Current: <u>850</u> mA.				
Ambient temperature: 28,1°C				
Monitored point:		264V 50Hz T (°C)	264V 60Hz T (°C)	Required T (°C)
		Correct to 40°C	Correct to 40°C	
1	Transformer winding 1 (T1)	83,6	84,6	120 (B)
2	Transformer winding 2 (T1)	85,2	86,4	120 (B)
3	Transformer core	82,4	83,7	For reference
4	Internal wire (AC lead wire)	69,5	70,4	80
5	Output cord (inside	68,8	70,2	80

IEC 61558-2-17						
Clause	Requirement – Test	Result - Remark			Verdict	
	enclosure)					
6	Enclosure (inside, near transformer)	64,0	65,2		For reference	
7	E-cap surface (EC2)	70,5	71,6		105	
8	Optocoupler (U2)	69,4	70,7		100	
9	Y-Cap (CY1)	74,7	75,8		125	
10	PCB (Top side, near U1 and transformer)	92,2	93,2		130	
11	PCB (Bottom side, under transformer)	78,0	79,2		130	
12	IC Surface (U1)	83,4	84,3		For reference	
13	Rectifying diode (D8)	88,7	89,4		For reference	
14	Enclosure surface (top)	53,5	54,3		80	
15	Supports (enclosure, near the AC plug)	47,4	48,5		85	
Temperature rise of winding:		R1(Ω)	R ₁ ()	T (°C)	Required T(°C)	Insulation class
Primary Winding		---	---	---	---	B
Secondary Winding		---	---	---	---	B
Remark: as requirement by the applicant, 0,9 and 1,1 times of input voltage and 40°C ambient condition have been considered, the test results have been calibrated to ambient 40°C.						

14	Heating (model LGSPSA240035zz)	P		
Test Voltage: <u>90</u> V <u>50/60</u> Hz Input Power: <u>10,8</u> / <u>10,9</u> W ,				
Input Current: <u>185</u> / <u>194</u> mA , Output Current: <u>350</u> mA.				
Ambient temperature: 27,9°C				
Monitored point:		90V 50Hz T (°C)	90V 60Hz T (°C)	Required T (°C)
		Correct to 40°C	Correct to 40°C	
1	Transformer winding 1 (T1)	88,0	87,5	120 (B)
2	Transformer winding 2 (T1)	84,4	84,0	120 (B)
3	Transformer core	80,0	79,7	For reference
4	Internal wire (AC lead wire)	66,9	66,6	80
5	Output cord (inside enclosure)	60,0	59,9	80
6	Enclosure (inside, near transformer)	57,0	56,7	For reference

IEC 61558-2-17						
Clause	Requirement – Test	Result - Remark			Verdict	
7	E-cap surface (EC2)	81,3	80,9		105	
8	Optocoupler (U2)	65,4	65,3		100	
9	Y-Cap (CY1)	68,7	68,3		125	
10	PCB (Top side, near U1 and transformer)	95,3	94,5		130	
11	PCB (Bottom side, under transformer)	72,2	72,1		130	
12	IC Surface (U1)	90,9	90,2		For reference	
13	Rectifying diode (D8)	84,9	84,8		For reference	
14	Enclosure surface (top)	51,5	51,5		80	
15	Supports (enclosure, near the AC plug)	47,7	47,5		85	
Temperature rise of winding:		R1(Ω)	R ₁ ()	T (°C)	Required T(°C)	Insulation class
Primary Winding		---	---	---	---	B
Secondary Winding		---	---	---	---	B
Remark: as requirement by the applicant, 0,9 and 1,1 times of input voltage and 40°C ambient condition have been considered, the test results have been calibrated to ambient 40°C.						

14	Heating (model LGSPSA240035zz)			P
Test Voltage: <u>264</u> V <u>50/60</u> Hz Input Power: <u>10,84</u> / <u>10,81</u> W ,				
Input Current: <u>90</u> / <u>88</u> mA , Output Current: <u>350</u> mA.				
Ambient temperature: 27°C / 27°C				
Monitored point:		264V 50Hz T (°C)	264V 60Hz T (°C)	Required T (°C)
		Correct to 40°C	Correct to 40°C	
1	Transformer winding 1 (T1)	88,8	88,4	120 (B)
2	Transformer winding 2 (T1)	85,3	85,0	120 (B)
3	Transformer core	80,9	80,4	For reference
4	Internal wire (AC lead wire)	64,5	63,9	80
5	Output cord (inside enclosure)	62,5	62,2	80
6	Enclosure (inside, near transformer)	57,8	57,5	For reference
7	E-cap surface (EC2)	74,2	73,5	105
8	Optocoupler (U2)	65,8	65,4	100

IEC 61558-2-17						
Clause	Requirement – Test			Result - Remark	Verdict	
9	Y-Cap (CY1)		68,9	68,5	125	
10	PCB (Top side, near U1 and transformer)		87,8	87,4	130	
11	PCB (Bottom side, under transformer)		73,1	72,6	130	
12	IC Surface (U1)		84,5	83,9	For reference	
13	Rectifying diode (D8)		94,4	94,0	For reference	
14	Enclosure surface (top)		52,9	52,6	80	
15	Supports (enclosure, near the AC plug)		50,5	49,8	85	
Temperature rise of winding:		R1(Ω)	R ₁ ()	T (°C)	Required T(°C)	Insulation class
Primary Winding		---	---	---	---	B
Secondary Winding		---	---	---	---	B
Remark: as requirement by the applicant, 0,9 and 1,1 times of input voltage and 40°C ambient condition have been considered, the test results have been calibrated to ambient 40°C.						

15	TABLE: Short-circuit and overload protection					P
	Model A: LGSPSA024150zz, Model B: LGSPSA100085zz Model C: LGSPSA241010zz, Model D: LGSPSA240035zz					—
	test voltage (V)	264 V / 50 Hz				—
	tamb1 (°C)	27,8	27,8	27,9	27,9	—
	tamb2 (°C)	27,9	27,8	27,8	27,9	—
	Model.....	A	B	C	D	—
	maximum temperature T of part/at:	T (°C) Correct to 40°C				allowed Tmax (°C)
	Winding 1 of transformer T1	99,6	98,4	93,7	104,2	175
	Winding 2 of transformer T1	101,9	104,5	88,0	99,5	175
	Internal wire (AC lead wire)	67,9	68,7	68,2	62,5	105
	Output cord	71,4	63,6	63,7	65,7	85
	Top of enclosure	57,9	55,4	54,9	61,5	105
	Bottom of enclosure	64,9	62,2	56,4	64,5	105
	Support	51,3	50,1	48,3	52,2	105
	Internal enclosure (near transformer)	68,8	67,1	63,5	70,9	For reference

IEC 61558-2-17						
Clause	Requirement – Test			Result - Remark		Verdict
temperature T of winding:	R ₁ (Ω)	R ₂ (Ω)	T (°C)	allowed T _{max} (°C)	insulation class	
—	—	—	—	—	Class B	
Note: as requirement by the applicant, 0,9 and 1,1 times of input voltage and 40°C ambient condition have been considered, tested with maximum normal load and test results have been calibrated to ambient 40 °C; The data of this table only for products were carry out overload test;						

26	TABLE: creepage distances and clearances and distances through insulation					N/A
	Test with three transformers					
cycles with 2 x working voltage between pri / sec	68 h at the temperature acc. Cl. 14 (min. 85 °C)	1 hour 25 °C	2 hour 0 °C	1 hour 25 °C		
1.						
2.						
3.						
4.						
5.						
6.						
7.						
8.						
9.						
10.						

26	TABLE: creepage distances and clearances and distances through insulation					N/A
	Test with three specially prepared specimens					
cycles with 2 x working voltage between pri / sec	68 h at the temperature acc. Cl. 14 (min. 85 °C)	1 hour 25 °C	2 hour 0 °C	1 hour 25 °C		
1						
2.						
3.						
4.						
5.						
6.						

IEC 61558-2-17						
Clause	Requirement – Test			Result - Remark		Verdict
cycles with 2 x working voltage between pri / sec	68 h at the temperature acc. Cl. 14 (min. 85 °C)	1 hour 25 °C	2 hour 0 °C	1 hour 25 °C		
7.						
8.						
9.						
10.						

Annex H	TABLE: Electronic circuits						P
	t1 (°C).....					27,8	—
	t2 (°C).....					27,9	—
	test voltage (V).....					264	—
component No.	fault	test voltage (V)	Test time	fuse No.	Fuse current (A)	Result	
Model: LGSPSA240035zz							
D8	S-C	264	< 1 S	F1	0,012	The unit shut down immediately, Recoverable after fault condition removed. No damage, no hazards.	
T1 Pin 9-10	S-C	264	< 1 S	F1	0,014	The unit shut down immediately, Recoverable after fault condition removed. No damage, no hazards.	
U1 Pin 6-3	S-C	264	< 1 S	F1	> 6,3	ZD2 damage, F1 open immediately, no hazards.	
U1 Pin 1-4	S-C	264	< 1 S	F1	0,005	The unit shut down immediately, Recoverable after fault condition removed. No damage, no hazards.	
U1 Pin 6-7	S-C	264	<1 S	F1	> 6,3	F1 open immediately, no hazards.	
EC2	S-C	264	<1 S	F1	> 6,3	F1 open immediately, no hazards.	
D1	S-C	264	<1 S	F1	> 6,3	F1 open immediately, no hazards.	
Model: LGSPSA241010zz							
U2 Pin 1-2	S-C	264	< 1 S	F1	0,023	The unit shut down immediately, Recoverable after fault condition removed. Output voltage is max.36V when no load. No damage, no hazards.	

IEC 61558-2-17						
Clause	Requirement – Test				Result - Remark	Verdict
U2 Pin 3-4	S-C	264	< 1 S	F1	0,005	The unit shut down immediately, Recoverable after fault condition removed. Output voltage is 0V when no load. No damage, no hazards. s.
U2 Pin 1	O-C	264	< 1 S	F1	0,024	The unit shut down immediately, Recoverable after fault condition removed. Output voltage is max.36,1V when no load. No damage, no hazards.
U2 Pin 4	S-C	264	< 1 S	F1	0,024	The unit shut down immediately, Recoverable after fault condition removed. Output voltage is max.36,1V when no load. No damage, no hazards.
<p>Note: as requirement by the applicant, 0,9 and 1,1 times of input voltage and 40°C ambient condition have been considered, test results have been calibrated to ambient 40 °C. Model LGSPSA240035zz and LGSPSA241010zz tested as representative.</p>						

A1:1998 to IEC 61558-1:1997

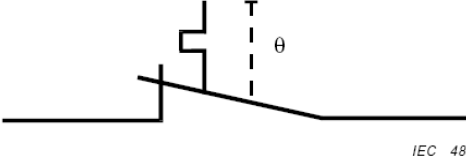
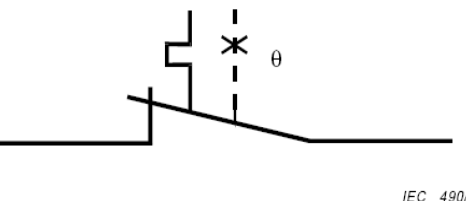
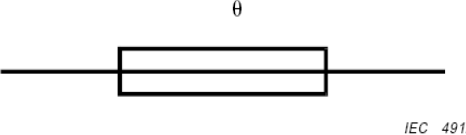
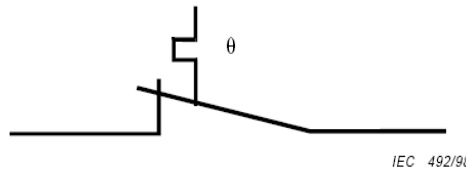
Clause	Requirement – Test	Result - Remark	Verdict
V	ANNEX V, SYMBOLS TO BE USED FOR THERMAL CUT-OUTS		N/A
V.2.1.1	Restored by manual operation  <p style="text-align: right;"><i>IEC 489/98</i></p>		N/A
V.2.1.2	Restored by disconnection of the supply  <p style="text-align: right;"><i>IEC 490/98</i></p>		N/A
V.2.1.3	Thermal link  <p style="text-align: right;"><i>IEC 491/98</i></p>		N/A
V.2.2	Self-resetting thermal cut-out  <p style="text-align: right;"><i>IEC 492/98</i></p>		N/A

Relevant requirement of IEC 61558-2-6:1997			
Clause	Requirement – Test	Result - Remark	Verdict
8	MARKING AND OTHER INFORMATION		P
8.11	Correct symbols:		P
	Fail-safe safety isolating transformer (IEC 61558-2-6:97)		N/A
	Non-short-circuit-proof safety isolating transformer (IEC61558-2-6:97)		N/A
	Short-circuit proof safety isolating transformer (inherently or non-inherently) (IEC 61558-2-6:97)	non-inherently short-circuit proof safety isolating transformer	P
8.101	For transformers with supply connection by cable or cord and a plug: Instruction sheet with information about the installation of the output circuits(IEC61558-2-6:97)	No supply cable	N/A

9	PROTECTION AGAINST ACCESSIBILITY OF HAZARDOUS LIVE PARTS		P
9.2	If the no load output voltage is \leq AC 35V peak or $<$ 60V ripple free- DC, live parts may be accessible (IEC61558-2-6:97).	See table 11 and 12	P
	If the no load output voltage is $>$ AC35V peak or $>$ DC 60 V, only one pole may become accessible (IEC61558-2-6:97)		N/A

10	CHANGE OF INPUT VOLTAGE SETTING		N/A
10.101	Portable transformers shall have only one rated supply voltage unless the transformer is not capable of producing an output voltage in excess of the limits allowed in the scope if the higher marked voltage is accidentally connected to the lower voltage winding		N/A





12	NO-LOAD OUTPUT VOLTAGE		P
12.101	No-load output voltage $<$ 50 V a.c. or $<$ 120 V d.c. (IEC 61558-2-6:97)		P
12.102	Difference between output voltage at no load and output (IEC 61558-2-6:97) Rated output (VA) Rated value %	See table 11 and 12	P

19	CONSTRUCTION		P
----	--------------	--	---

Relevant requirement of IEC 61558-2-6:1997			
Clause	Requirement – Test	Result - Remark	Verdict
19.1	Input and output circuits electrically separated (IEC 61558-2-6:97)		P
	No possibility of any connection between these circuits (IEC 61558-2-6:97)		P
19.1.1	The insulation between input and output winding(s) consist of double or reinforced insulation (exeption see 19.1.3) (IEC 61558-2-6:97)		P
	Class I transformers (IEC 61558-2-6:97)		N/A
	Insulation between input windings and body consist of basic insulation (IEC 61558-2-6:97)		N/A
	Insulation between output windings and body consist of supplementary insulation (IEC 61558-2-6:97)		N/A
	Class II transformers (IEC 61558-2-6:97)		P
	Insulation between input windings and body consist of double or reinforced insulation (IEC 61558-2-6:97)	Reinforced insulation	P
	Insulation between output windings and body consist of double or reinforced insulation (IEC 61558-2-6:97)	Reinforced insulation	P
19.1.2	Class I transformers (IEC 61558-2-6:97)		N/A
	The insulation between input and output windings via intermediate metal parts (not connected to the body) consist of double or reinforced insulation (IEC 61558-2-6:98)		N/A
	Class II transformers (IEC 61558-2-6:97)		—
	The insulation between input windings and body, and between output windings and body via intermediate metal part consist of double or reinforced insulation (IEC 61558-2-6:97)	Reinforced insulation between input windings and enclosure	P
	Class I and Class II transformers (IEC 61558-2-6:97)		—
	The insulation between intermediate metal part and input or output windings consist of at least basic insulation (IEC 61558-2-6:97)	Core of transformer T1 considered as primary circuits	N/A
19.1.3	Class I transformers with protective screening (IEC 61558-2-6:97)		N/A
	The insulation between input winding and protective screen consist of basic insulation (rated input voltage)		N/A

Relevant requirement of IEC 61558-2-6:1997			
Clause	Requirement – Test	Result - Remark	Verdict
	The insulation between output winding and protective screen consist of basic insulation (rated output voltage)		N/A
	The protective screen consist of metal foil or a wire wound screen extending the full width of the windings		N/A
	The cross-section of the screen is at least corresponding to the rated current of the overload device		N/A
	Lead-out wires of the screen soldered or fixed in an equally manner		N/A
19.1.4	Protective screening (Cl. 19.1.3) is not allowed för transformers with plug connection to the mains (IEC 61558-2-6:97)		P
19.101	Portable transformers with rated output $\leq 630VA$ in class II construction. (IEC 61558-2-6:97)	Class II	P
19.102	No connections between output winding and body or protective circuit - if any (IEC 61558-2-6:97)		P
	For associated transformers these connections are allowed in compliance with the relevant equipment standard (IEC 61558-2-6:97)		N/A
19.103	No capacitors which electrically connect input and output circuits (IEC 61558-2-6:98)	One approved Y1 capacitor connect between primary and secondary circuits	N/A
19.104	The distance between input and output terminals for the connection of external wiring is 25 mm		P
20	COMPONENTS		P
20.3	Plug and socket-out on the output side shall comply with IEC 884-2-4 and IEC 906-3		P
26	CREEPAGE DISTANCES AND CLEARANCES		P
	Box 1 of table 13, table C1 and table D1 is not applicable		P

National deviation			
Clause	Requirement – Test	Result - Remark	Verdict
<p>IEC 61558-1, 1st ed. + Amd 1 and IEC 61558-2-6, 1st ed. (EN 61558-1, 1st ed. + Amds 1 and 11 and EN 61558-2-6, 1st ed.)</p> <p>GROUP DIFFERENCES, NATIONAL DEVIATIONS AND SPECIAL NATIONAL CONDITIONS IN THE CENELEC COUNTRIES</p> <p>S = Special National Condition D = National Deviation C = CENELEC Common Modification</p>			

8.7	<p>S(FR): (Décret n . 66.660 du 8 septembre 1966 en application de la loi n . 60.1375 du 21 décembre 1960)</p> <p>The general French regulations prescribe that transformers having a rated supply voltage of 127 V require also the value 220 V.</p>		N/A
	<p>Supply cords of class I transformers which are supplied without a plug, shall be provided with a visible tag containing the following text:</p> <p style="text-align: center;">Vigtigt! Lederen med grøn/gul isolation må kun tilsluttes en klemme mærket</p> <p style="text-align: center;"> eller </p> <p><small>(Important! The conductor having green/yellow insulation shall only be connected to a terminal marked  or .)</small></p> <p>If it is essential for the safety of the transformer, the tag shall be provided either with a wiring diagram showing the connection of the other conductors or with the following text:</p> <p style="text-align: center;">For tilslutning af de øvrige ledere, se medfølgende installationsvejledning.</p> <p>(For the connection of the other conductors, see the enclosed instructions for installation.)</p>		N/A

National deviation			
Clause	Requirement – Test	Result - Remark	Verdict
20.3	<p>C: Add a note after the second paragraph:</p> <p>NOTE: As IEC 60906-3 covers only 6, 12, 24, 48 V, the attention of the appliance manufacturer is called that:</p> <ul style="list-style-type: none"> - either their appliance with intermediate supply voltage shall be able to withstand the immediate upper voltage; - or, to ask for SC 23C of IEC to design intermediate values. <p>Other plugs and socket-outlets systems are allowed for associated transformers only.</p>		N/A
22.5	<p>Replace “code designation 53 of IEC 60245-1” by “code designation H05 RR-F” and replace “code designation 53 of IEC 60227-1” by “code designation H05 VV-F or H05 VVH2-F”.</p> <p>Add:</p> <p>Power supply cords of transformers with protection index greater than IPX0 shall be not lighter than ordinary polychloroprene sheathed cord (code designation H05 RN-F), except for transformers for indoor use only. For IPX0 transformers with a mass less than 3 kg, the power supply cords shall be not lighter than H03 VV-F.</p>		N/A

National deviation															
Clause	Requirement – Test	Result - Remark	Verdict												
22.8	<p>Denmark (Danish Heavy Current Regulation, section 107-2-D1)</p> <p>Replace the second paragraph by the following:</p> <ul style="list-style-type: none"> - Stationary class I transformers having a protection index IP 20 <p style="margin-left: 40px;">Section 107-2-D1</p> <p style="margin-left: 40px;">Standard Sheet DK 2-1a</p> <p style="margin-left: 40px;">or</p> <p style="margin-left: 40px;">IEC 83, Standard Sheet C 2b, C 3b or C4</p> - Stationary class I transformers having a protection index higher than IP 0 and portable class I transformers with a rated input exceeding 630 V <p style="margin-left: 40px;">Section 107-2-D1</p> <p style="margin-left: 40px;">Standard Sheet DK 2-1a</p> - Class II transformers <p style="margin-left: 40px;">IEC 83,</p> <p style="margin-left: 40px;">Standard Sheet C5 or C8</p> <p>If multi-phase transformers and single-phase transformers having a rated current exceeding 10 A are provided with a supply cord and plug, the plug shall comply with the following table:</p> <table border="1" style="width: 100%; border-collapse: collapse;"> <thead> <tr> <th style="width: 20%;">Class</th> <th colspan="2">Plug **</th> </tr> </thead> <tbody> <tr> <td></td> <td style="text-align: center;">Section 107-2-D1 Standard sheet</td> <td style="text-align: center;">EN 60309-2 Standard sheet</td> </tr> <tr> <td style="text-align: center;">I</td> <td style="text-align: center;">DK 6-1a</td> <td style="text-align: center;">2-II, 2-IV</td> </tr> <tr> <td style="text-align: center;">II</td> <td style="text-align: center;">DK 6-1a*</td> <td style="text-align: center;">2-II, 2-IV*</td> </tr> </tbody> </table> <p>* Earthing contact not connected. ** These plugs are also allowed for transformers having a rated current equal to or less than 10 A.</p>	Class	Plug **			Section 107-2-D1 Standard sheet	EN 60309-2 Standard sheet	I	DK 6-1a	2-II, 2-IV	II	DK 6-1a*	2-II, 2-IV*		N/A
Class	Plug **														
	Section 107-2-D1 Standard sheet	EN 60309-2 Standard sheet													
I	DK 6-1a	2-II, 2-IV													
II	DK 6-1a*	2-II, 2-IV*													
	<p>S (SE): Power supply flexible cabled and cords of single-phase transformers having an input current at rated output not exceeding 16 A, shall be provided with a plug complying with CEE Publication 7, Standard sheets to be applied as follows:</p> <p>Class I transformers Standard sheet IV, VI or VII;</p> <p>Class II transformers Standard sheet XVI or XVIII.</p>		N/A												
23.1	<p>Replace in the third paragraph “IEC 60947-7-2” by “IEC 60947-7-1”.</p>		N/A												

National deviation			
Clause	Requirement – Test	Result - Remark	Verdict
Annex S	<p>C: Bibliography</p> <p>Add the following notes for the standards indicated:</p> <p>IEC 60038 NOTE: Harmonized as HD 472 S1:1989 (modified).</p> <p>IEC 60555-1 NOTE: Harmonized as EN 60555-1:1987 (not modified).</p> <p>CISPR 11 NOTE: Harmonized as EN 55011:1991 (modified).</p> <p>CISPR 14 NOTE: Harmonized as EN 55014-1:1993 (not modified).</p>		P
	<p>D (DK): Information concerning national differences is given by DEMKO on request.</p> <p>See also Group Differences.</p>		N/A
	<p>D (SE): See Group Differences</p>		N/A
Annex ZA (normative)	<p>Special national conditions</p> <p>National characteristic or practice that cannot be changed even over a long period, e.g. climatic conditions, electrical earthing conditions. If it affects harmonization, it forms part of the European Standard or Harmonization Document.</p> <p>For the countries in which the relevant special national conditions apply these provisions are normative, for other countries they are informative.</p>		P

24.1	TABLE: List of critical components					P
Object/part No.	Manufacturer/ trademark	Type/model	Technical data	Standard (Edition / year)	Mark(s) of conformity1)	
Enclosure	SABIC INNOVATIVE PLASTICS CHINA CO LTD	923(f1)	V-0, 120°C, Thickness 2,0mm	Applicable parts of IEC 61558-1	Tested in appliance	
PCB	Various	Various	130°C minimum, V-0	UL94	UL	
Fuse (F1)	WALTER ELECTRONIC CO LTD	ICP	T2A, 250Vac, size: 3,6 x 10 mm	IEC/EN 60127-1 IEC/EN 60127-3	VDE 40012824	
Alternative	XC ELECTRONICS (SHENZHEN) CORP LTD	3T	T2A, 250Vac, size: 3,6 x 10 mm	IEC/EN 60127-1 IEC/EN 60127-3	VDE 40019614	
Alternative	Dongguan Better Electronic Technology Co., Ltd.	334	T2A, 250Vac, size: 3,6 x 10 mm	IEC/EN 60127-1 IEC/EN 60127-3	VDE 40025428	
Varistor (VAR1) (optional)	LIEN SHUN ELECTRONICS CO., LTD.	ZOV 05D431K	Min. 300Vac, 85°C	IEC 61051-1; IEC61051-2; IEC61051-2-2	VDE 40005858	
Bridge- Capacitors (CY1)	HSUAN TAI ELECTRONICS CO LTD	CY	Max. 1000pF, min. 250Vac, 125°C, Y1 type	IEC 60384-1; EN 60384-14: 2005	VDE 40008912	
Alternative	Various	Various	Max. 1000pF, min. 250Vac, 125°C, Y1 type	IEC 60384-1; EN 60384-14: 2005	S & other EU certification marks	
Optocoupler (U1)	FAIRCHILD SEMICONDC TOR	H11A817	Int. CR/ Ext. Cr/ Dti: >= 7,0 / >=7,0 / > 0,4 mm	EN 60747-5-2	VDE 40026857	
Alternative	EVERLIGHT ELECTRONICS CO., LTD.	EL817	Int. CR/ Ext. Cr/ Dti: > 6,5 / > 8 / > 0,4 mm	EN 60747-5-2	VDE 132249	
Heat Shrinkable Tube For Fuse	SHENZHEN WOER HEAT- SHRINKABLE MATERIAL CO LTD	RSFR	600V, 125°C	Applicable parts of IEC 61558-1	Tested in appliance	
Alternative	DONGGUAN QUANTAI ELECTRONICS CO LTD	T-2	600V, 125°C	Applicable parts of IEC 61558-1	Tested in appliance	
Input Leading Wire	Various	Various	105°C, 300V, VW-1	Applicable parts of IEC 61558-1	Tested in appliance	
Output Cord	Various	Various	80°C, 300V,	Applicable parts of IEC 61558-1	Tested in appliance	

Transformer (T1) for output: 2,4V-8,0Vdc	LYGO ELECTROIC PRODUCTS MFY.	LG8W4-05V-01	130°C, class B, primary N1: Ø0,18X124Ts, secondary N2: 0,5X10Ts	Applicable parts of IEC 61558-1	Tested in appliance
Transformer (T1) for output: 8,1V-15,0Vdc	LYGO ELECTROIC PRODUCTS MFY.	LG8W4-12V-01	130°C, class B, primary N1: Ø0,18X124Ts, secondary N2: 0,5X21Ts	Applicable parts of IEC 61558-1	Tested in appliance
Transformer (T1) for output: 15,1V-24,1Vdc	LYGO ELECTROIC PRODUCTS MFY.	LG8W4-18V-01	130°C, class B, primary N1: Ø0,18X124Ts, secondary N2: 0,3X40Ts	Applicable parts of IEC 61558-1	Tested in appliance
Bobbin Material (T1)	CHANG CHUN PLASTICS CO LTD	T375J	Phenolic, V-0,150°C, 0,71mm Min.	Applicable parts of IEC 61558-1	Tested in appliance
Alternative	SUMITOMO BAKELITE CO LTD	PM-9630	Phenolic, V-0,150°C, 0,71mm Min.	Applicable parts of IEC 61558-1	Tested in appliance
Triple Insulated Wire Used In T1	GREAT LEOFLON INDUSTRIAL CO., LTD.	TRW(B)	130°C, class B	EN 60950 IEC 60950	VDE 136581
Alternative	HOI LUEN ELECTRICAL	THL-B	130°C, class B	EN 60950 IEC 60950	VDE 40020365
Alternative	DAH JIN TECHNOLOGY CO., LTD.	TLW-B	130°C, class B	EN 60950-1 IEC 60950-1	VDE 40008834
Alternative	COSMOLINK CO. LTD.	TIW-M	130°C, class B	EN 60950 IEC 60950	VDE 138053
Insulation Tape	CHANG SHU LIANG YI TAPE INDUSTRY CO LTD	LY-02	130°C	Applicable parts of IEC 61558-1	Tested in appliance
Alternative	BONDTEC PACIFIC CO LTD	371F	130°C	Applicable parts of IEC 61558-1	Tested in appliance
¹⁾ An asterisk indicates a mark which assures the agreed level of surveillance					

Model: LGSPSAxxxxyyzz
 Input: 100-240Vac 50/60 Hz 190 mA

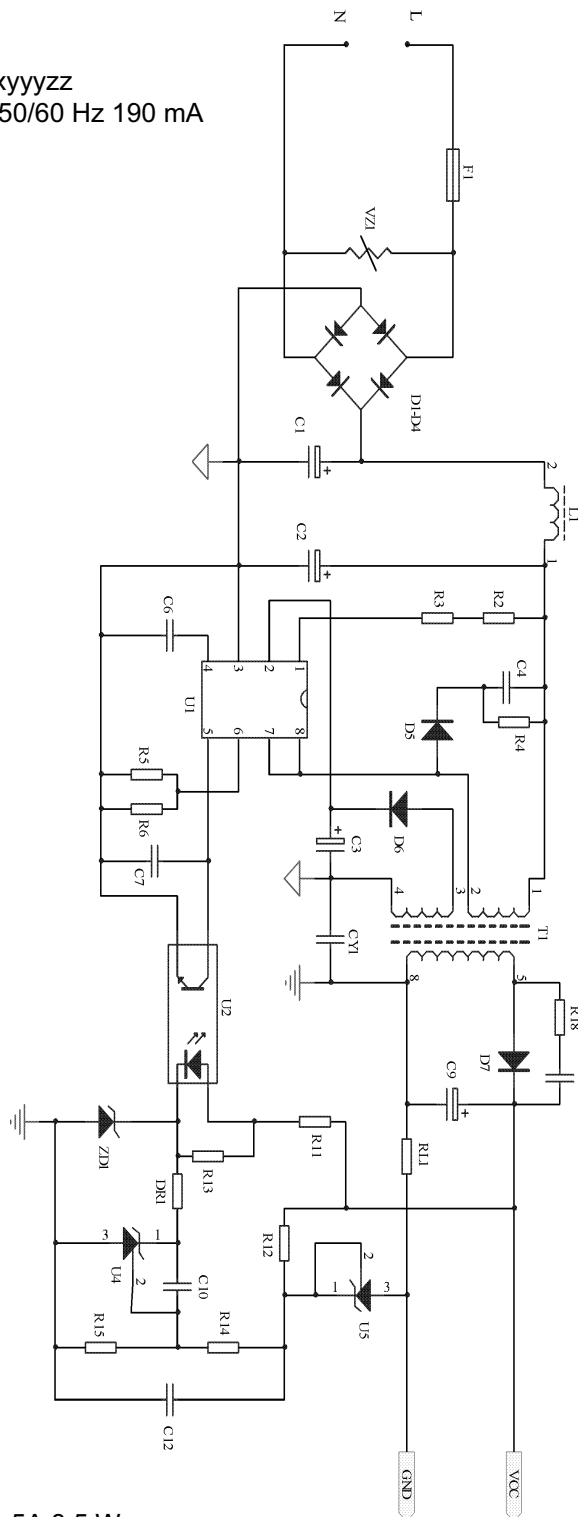

Output: 2,4-24,1Vdc, 0,05-1,5A 8,5 W max.

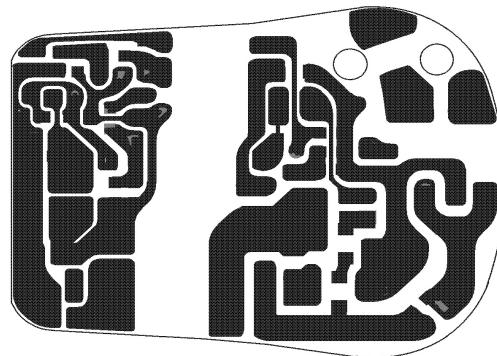
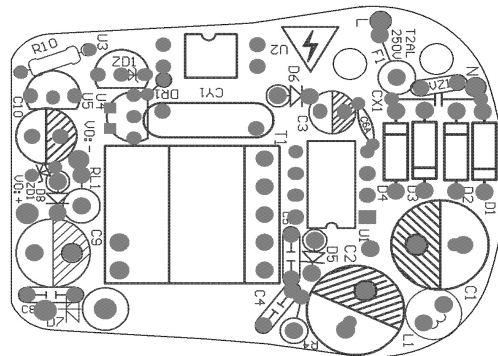
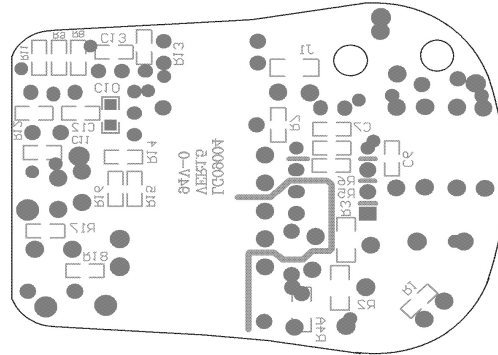



External view of EU plug type, Model: LGSPSAxxxxxyyEP

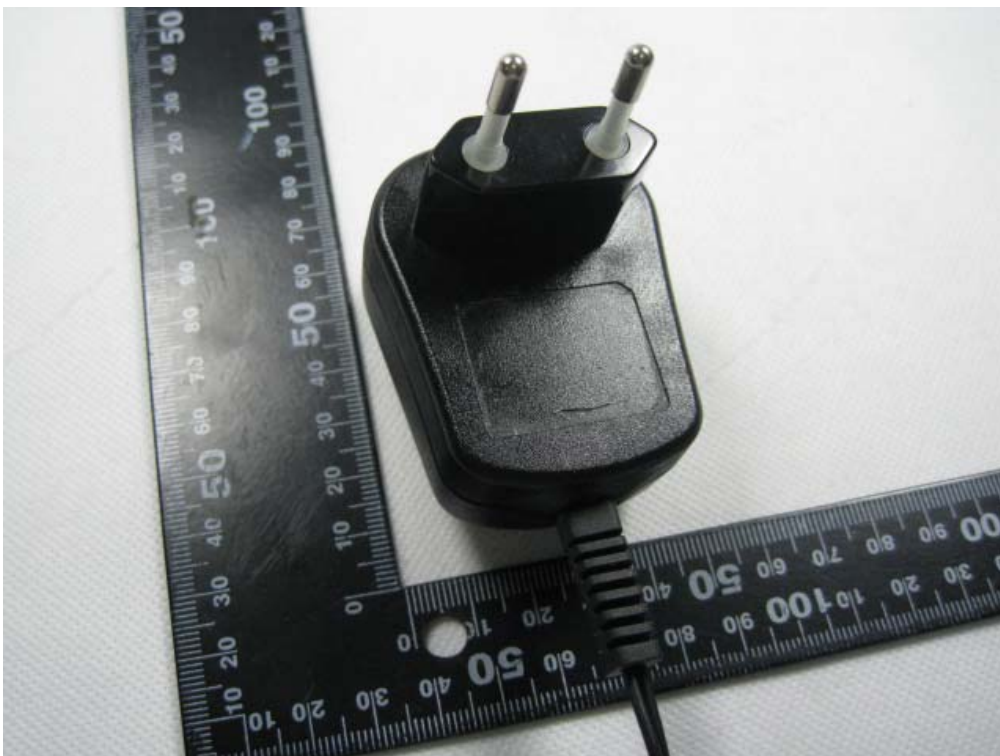

External view of EU plug type, Model: LGSPSAxxxxxyyEP



External view of AU plug type, Model: LGSPSAxxxxyyAU



External view of AU plug type, Model: LGSPSAxxxxyyAU

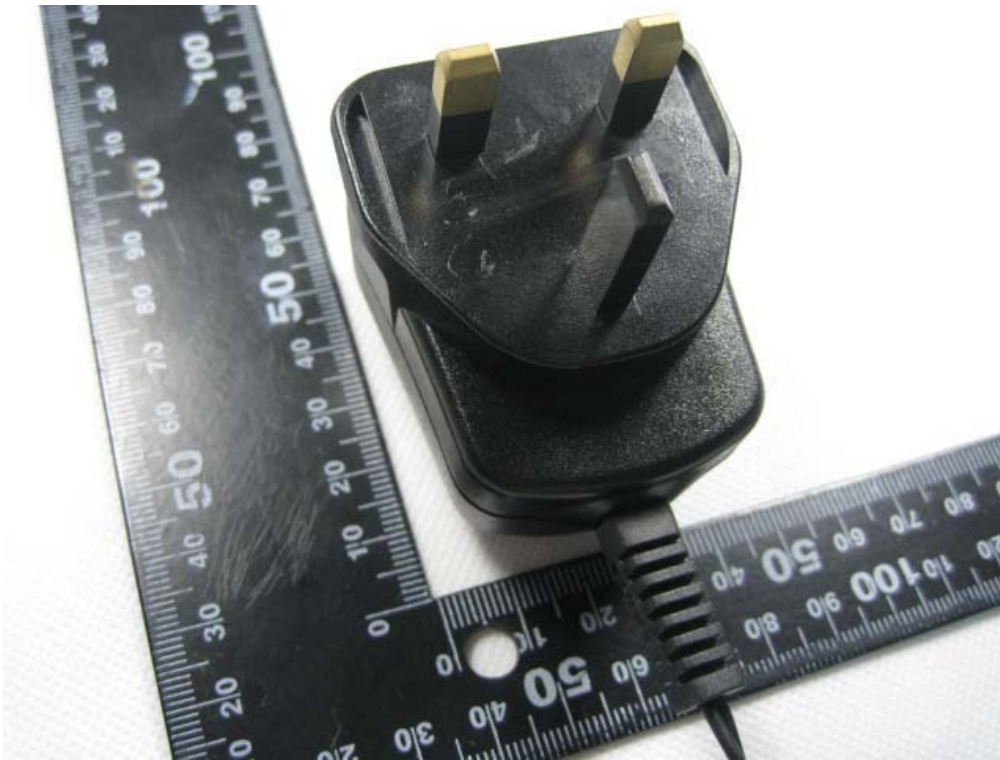

External view of UK plug type, Model: LGSPSAxxxxyyBS



External view of UK plug type, Model: LGSPSAxxxxyyBS

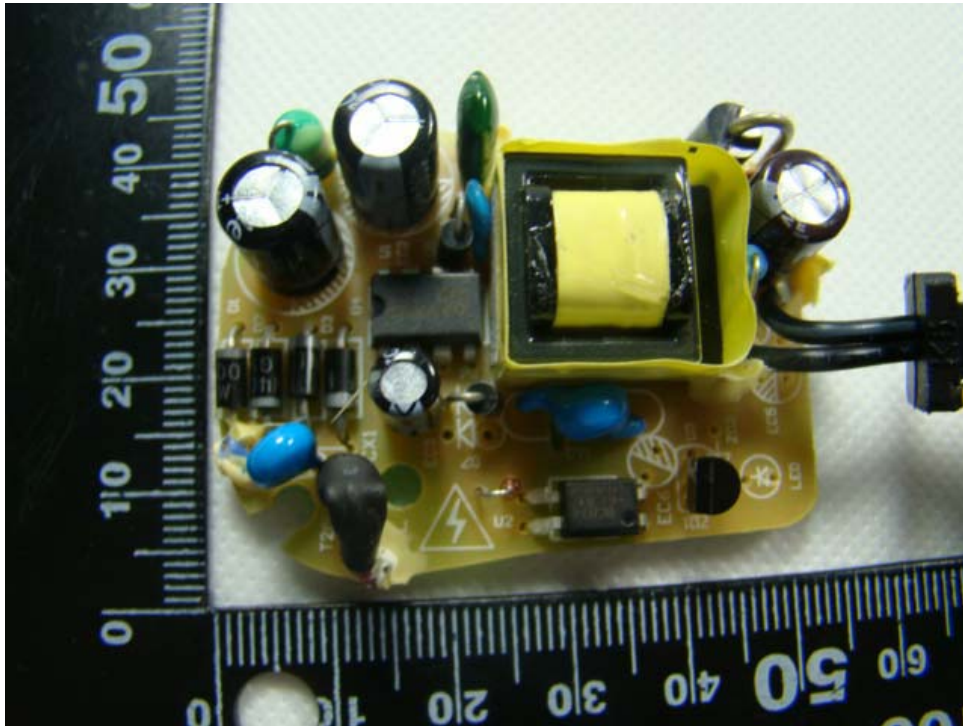

Internal view of EU plug type, Model: LGSPSAxxxxxyyEP, same as UK type and AU type

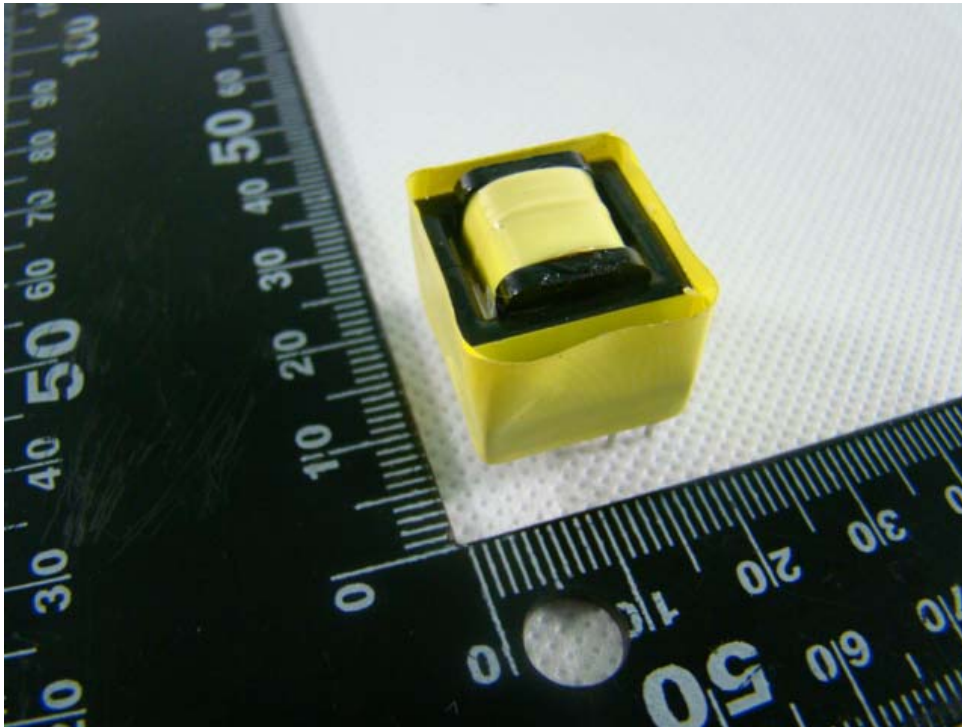

Transformer view

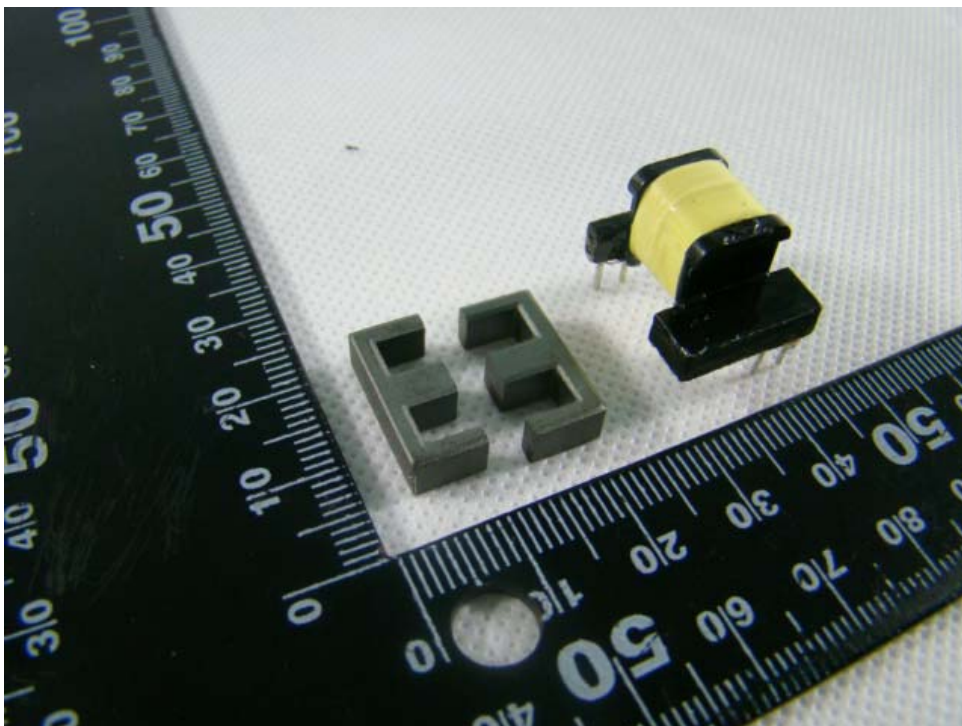

Transformer view

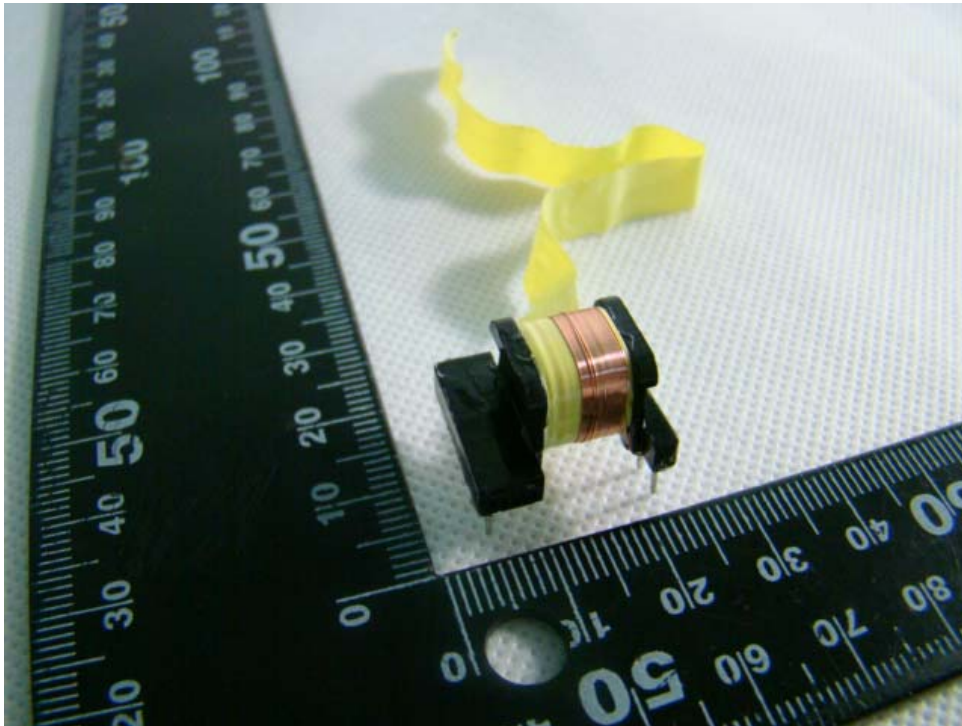

Transformer view, 1st winding: primary- N4

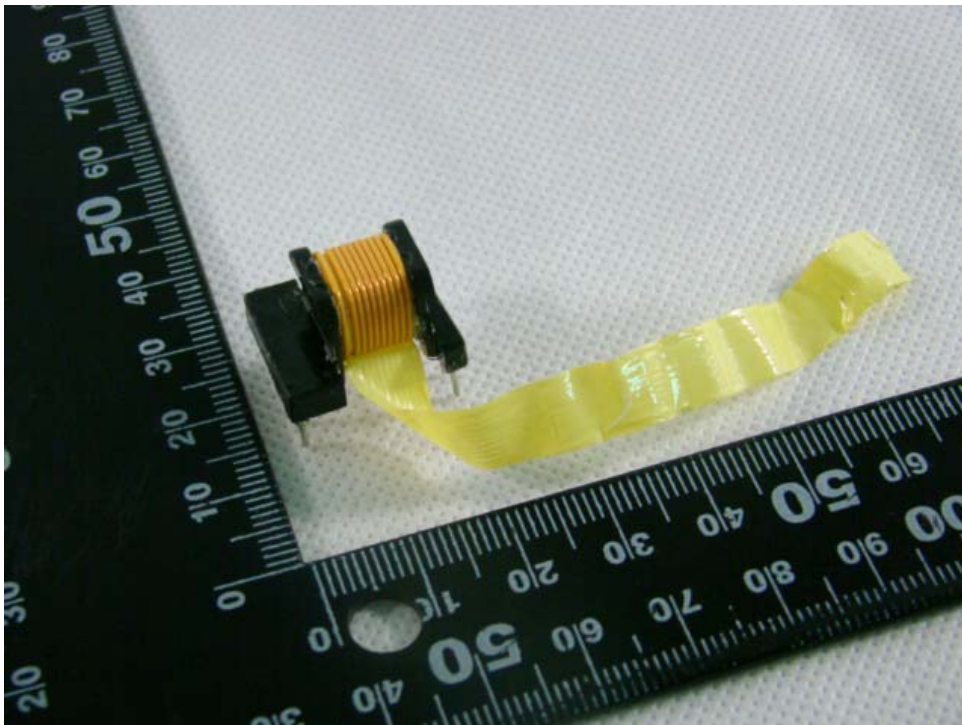

Transformer view, 2nd winding: secondary- N3

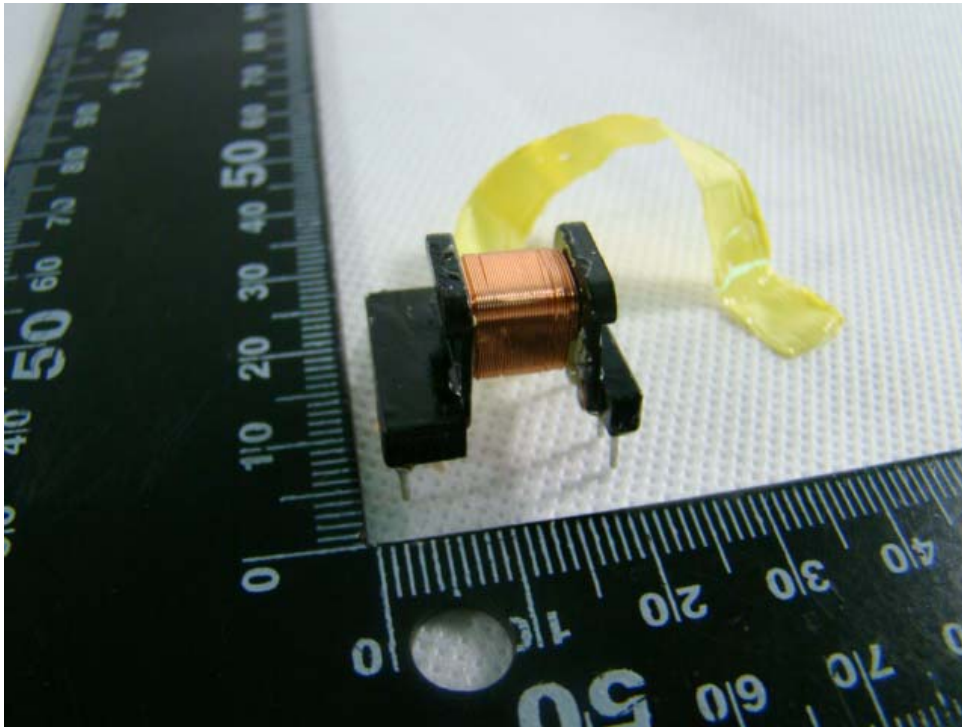

Transformer view, 3rd winding: primary- N2

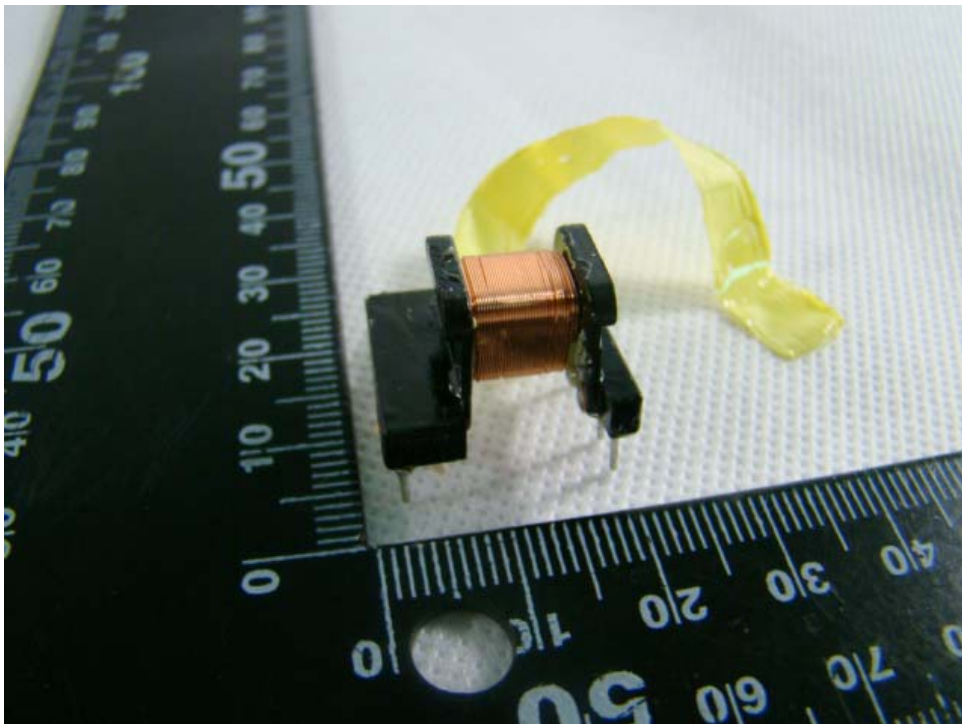

Transformer view, 4th winding (last winding): primary- N1



LYGO Int. Co. Ltd.
利高電業國際有限公司

Unit1902, 19/F, Prosperity Plaza, 6 Shing Yip Street, Kwun Tong, Hong Kong.

Customer information

Model: LGSPSAxxxxyyzz
Input: 100-240Vac, 50/60Hz, 190mA
Output: 2.4-24.1Vdc, 0.05-1.5A

Kundeninformation

Modell: LGSPSAxxxxyyzz
Eingang: 100-240Vac, 50/60Hz, 190mA
Ausgang: 2.4V-24.1Vdc, 0.05-1.5A

Safety Notes



The maximum ambient temperature during use of the appliance must not exceed 40°C

Naked flame sources, such as candles, must not be placed on the appliance,

In case of broken cords or plugs the appliance must be disposed.

The appliance does not require much attention. If you want to clean it, please use only dry cloths or a brush.

The external flexible cable or cord cannot be replaced. If the cord is damaged the appliance should be scrapped.

Sicherheitshinweise



Die Umgebungstemperatur während des Einsatz des Gerätes darf 40°C. Nicht überschreiten.

Offene Brandquelle, wie z.B. Kerzen, dürfen nicht auf das Gerät gestellt werden.

Im Falle beschädigter Leitungen oder Stecher muss das Gerät entsorgt werden.

Das Gerät ist sehr wartungsarm. Falls Sie es reinigen wollen, benutzen Sie einen trockenen Lappen oder einen Pinsel.

Das Netzkabel kann nicht ersetzt werden. Wenn das Netzkabel defekt ist, sollte das Schaltnetzteil entsorgt werden.

Symbols used:



Indoor use only



Protection class II appliance



The appliance shall not be disposed together with the normal waste. It must be recycled.

Benutze Zeichen:



Nur Für Innenräume geeignet



Schutzklasse II Gerät



Das Gerät darf nicht zusammen mit dem normalen Hausmüll entsorgt werden. Es muss recycelt werden.

Equipment's combined with two-pole plug (Class II)

Supplementary tests on plug portion according to EN 50075 or IEC 60884-1

	Requirement - Test	References to clause in		Result-Remark	Comply
		IEC 60884-1	EN 50075		
1	Plug portion				P
	CEE 7 Standard Sheet			XVI	P
	EN 50 075				P
2	Dimensions				P
	Checking dimensions by measuring and by gauges according to Standard sheet				P
	The edges of the metal-pins, Chamfered or rounded off				P
3	Protection against electric shock				P
a	Test finger (75N, 1 min in 35°C) or Applicable appliance standard	10.1	8.1		P
b	Single pole insertion. Checked with gauge: Fig 4 or C19A or C19B (CEE 7)	9.2	8.2		P
c	Compression test 150 N, 5 min.	10.1	13.1		P
d	External parts made of insulating material	10.4	8.3		P
4	Construction				P
a	Test on pins which are not solid	14.2	9.3		N/A
b	Pins shall be locked against rotation 0.4 Nm 1 min.	24.2	13.2		P

	Requirement - Test	References to clause in		Result-Remark	Comply
		IEC 60884-1	EN 50075		
		IEC 60884-1	EN 50075		
c	Pins shall be adequately fixed in the body 1 min. Temperature 70°C 40 N for plugs < 2,5 A 50 N for plugs > 2,5 A	24.10	13.4		P
d	Pins of copper or copper alloy min 58% copper or equivalent	26.5-26.6	15.3	63 - 67 %	P
e	Plug shall not impose undue strain on fixed socket-outlets, 0,25 Nm	14.23.2		Max. 0,027 Nm	P
f	Abrasion test on the insulating sleeves 20 000 movements	24.7	13.3		P
5	Resistance of insulating material to abnormal heat, to fire and to tracking				P
a	Compression test 1 h in 80°C	25.4	14.1.2		N/A
b	Glow-wire test 750°C	26.1.1	17		P
c	Resistance to tracking 175V (other than ordinary)	28.2			N/A

Two-pin plugs for class II appliances (Up to 2.5 A rating)

According to EN 50075 - Standard Sheet and IEC 60083 - Standard C5

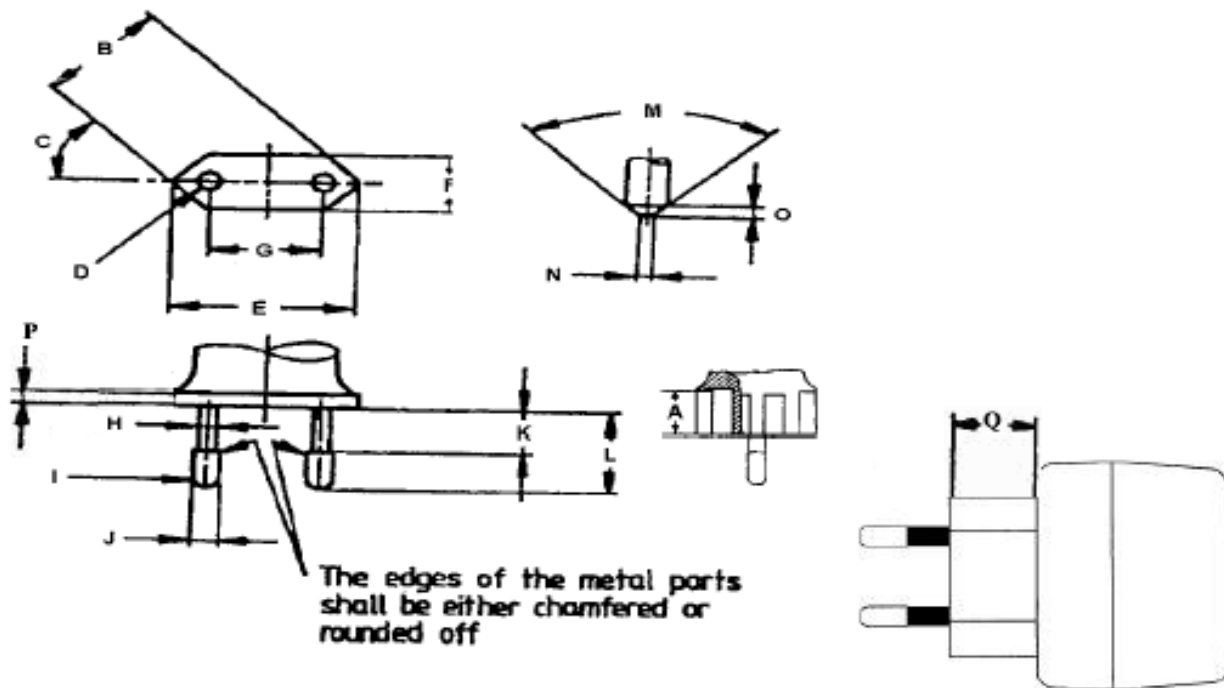

Symbol	Requirement (mm)	Measured (mm)
A	≥ 16,5	--
B	25,6 - 26,6	26,14 / 26,33
C	45 °	45 °
D	R 5,0 – 6,0	5,24
E	34,6 – 36,0	34,84 / 35,42
F	13,0 – 14,4	13,76 / 14,33
G	Engagement 18,0 – 19,2	18,42
G	End 17,0 – 18,0	17,47
H	Within 4 mm from engagement face ≤ 4.0mm	3,83
	Above 4 mm from engagement face ≤ 3.8mm	3,39

Symbol	Requirement (mm)	Measured (mm)
I	—	--
J	3,94 – 4,06	3,96
K	10,0 – 11,0	10,20
L	18,5 – 19,5	19,03
M	≤ 90 °	--
N	0,7 – 1,7	--
O	≤ 2,0	0,1
P	≥ 4,0	--
Q	≥ 18,0	18,26

Equipment's combined with BS-plug (Class II)

Supplementary tests on plug portion according to BS1363: Part 3 + Amd 9543 + Amd 14225 + Amd 14540+ Amd 17437

Clause	Requirement - Test	Result-Remark	Comply
12.1	Dimensions (Checked according to figure 4)		P
12.2	Outline of plug shall not exceed the dimension shown in Figure 4 for a distance of not less than 6.35 mm from the engagement surface		P
	Pin disposition, length and body outline shall be checked by use of the gauge shown in Figure 5		P
12.3	L/N pin was more than 9.5 mm from the periphery of the plug measured along the engagement surface		P
12.7	The base and cover of rewirable plugs shall be adaptor plugs having the cover fixed by screws shall be firmly secured to each other, It shall not be possible to remove the cover unless the adaptor is completely withdrawn from the socket-outlet. Fixing screws shall be captive. The test is carried out using apparatus similar to that shown in Figure 6		N/A
12.9	After the temperature rise test (clause 16). Use test probe 11 of BS EN 61032:1998 is applied a force 30 -5/0 N. During and after the test, it was not possible to touch the live parts		P
12.11	Adaptor plug pins shall be constructed of brass, except for sleeves of pins as specified in 12.18		P
	All exposed surfaces of the adaptor plug pins shall be smooth and free from burrs or sharp edges and other irregularities which could cause damage or excessive wear to corresponding socket contacts or shutters		P
	Those surfaces of the non-solid adaptor plug pins which are visible when the adaptor is correctly assembled shall be free of apertures		N/A
	All seams and joints of non-solid adaptor plug pins shall be closed over their entire length		N/A
	For solid pins and ISODs, conformity shall be checked by 12.11.4.1		P

	For non-solid pins, compliance shall be checked by 12.11.4.2		N/A
	For ISOD, compliance shall be checked by 12.11.4.3		P
	Adaptors with non-solid pins and ISODs shall not cause excessive wear to socket contacts or shutters of socket-outlets in accordance with BS 1363-2:1995. For adaptors with ISODs, compliance shall be checked by 12.11.5.2		P
	Adaptor plug pins and ISODs (if any) shall have adequate mechanical strength to ensure that they cannot be distorted by twisting. Apply a torque $1\text{N.m} \pm 10\%$ for $60 \pm 5/0 \text{ S}$. After each pin has been separately twisted, the plug was fit the gauge in fig. 5. Repeated with opposite direction		P
12.13	Adaptors shall be so designed that when fully assembled the pins are adequately retained in position such that there is no likelihood of them becoming detached from the adaptor during normal use		P
	Each pin is subjected for $60 \pm 5/0 \text{ S}$ to a pull of $100 \pm 2/0 \text{ N}$ without jerks in the direction of the major axis. The plug is mounted using the steel plate shown in fig.7. The apparatus is placed within an oven and the pull is applied at least 1 h after the plug body has attained the test temperature of $70^\circ\text{C} \pm 5^\circ\text{C}$ while maintained at this temperature. After the test, the plug pin shall fit into the gauge and comply with 12.2.1		P
12.14	The degree of flexibility of mounting of the plug pins or the angular movement of the pins in the base shall be not greater than $3^\circ 30'$. See fig. 8		P
	Test procedure refers to standard. During each test, the declination from the horizontal measured on the scale was not exceed $3^\circ 30'$ and comply with 12.2.1		P
12.18	Live and neutral adaptor plug pins shall be fitted with insulating sleeves. See fig.4. Sleeves shall not fitted to any earthing adaptor plug pin		P
12.19.3	Abrasion test – 10 000 times in each direction(20 000 movements) at a rate of 25 movements to 30 movements per min. (fig. 9)		P

	After the test, the sleeve shall show no damage and also shall not have been penetrated or creased, satisfy the tests in 12.19.2		
13.10	The total mass of the equipment with all specified connectors shall not exceed 800 g. The torque exerted on a socket shall not exceed 0.7 N·m. The test apparatus as Figure 37		P
	Additional: Products with torque exceeding 0.25Nm do not comply with the main standard hence full compliance with the main standard cannot be claimed	0,019 Nm max.	P
Additional test for ISODs according to BS1363: Part 1 + Amd 9541 + Amd 14539			
12.9.1	All exposed surfaces of plug pins shall be smooth and free from burrs or sharp edges and other irregularities which could cause damage or excessive wear to corresponding socket contacts or shutters		P
12.9.4	Apply a force of 1100 -10/0N at a rate not exceeding 10 mm/min. After this test the plug should fit the gauge to fig. 5		P
	Apply a force of 400 +10/0N at a rate 10 ± 2 mm/min. Deflection shall not exceed 1.5 mm. After this test the plug should fit the gauge to fig. 5		P
12.9.6	ISODs shall have adequate mechanical strength to ensure that they cannot be distorted by twisting. Apply a torque 1N.m ± 10% for 60 +5/0 S. After each pin has been separately twisted, the plug shall fit the gauge in fig. 5. Repeated with opposite direction		P

Equipment's combined with Australia plug.

Supplementary tests on plug portion according to AS/NZS 3112: 2004+A1: 2006.

Cl.	Requirement – Test	Main clause	Verdict
J 2.2.1	Plug pins of plug portion	2.2	P
	Material for pins	2.2.1	P
	The material of current carrying parts of plug pins should be copper, or copper alloy containing at least 58% copper for parts made from cold rolled sheet or at least 50% copper for other parts; or stainless steel containing at least 13% chromium and not more than 0.09% carbon.		P
	Assembly of pins	2.2.2	P
	The exposed ends and the contact portion of plug pins shall be smooth and free from openings or indentations.	2.2.3	P
	Live parts of insulated pin plugs shall not be exposed when the plug is partially or fully engaged with the associated socket.	2.2.4	P
	Plug up to 15A complying with Figure 2.1(a), 2.1(c) or 2.1(f) and of the insulated pin plug type do not need to comply with the R20.0 +/-1 mm of Figure 2.1(e).		P
J 2.2.2	Ratings and dimensions for low voltage plug portions	2.8	P
	Low voltage flat-pin plugs shall conform to the appropriate dimensions shown in Figure 2.1.	2.8.1	P
	The distance between a live pin of any plug and the edge of the moulding of the plug, shall be not less than 9 mm.		P
	No point on the front face of the plug is more than 0.5 mm.		P
	Compliance with dimensional requirements of Figure 2.1	2.8.4	P
	Low voltage flat-pin or combination of flat and round pin, plugs having ratings up to 15A of Figure 2.1(a1), Figure 2.1(c), Figure 2.1(d), Figure 2.1(f) or Figure 2.1(g) type shall comply with the dimensional requirements of Figure 2.1(e).		P
	Plugs with insulated pins, complying with this Standard, need not comply with dimension R20+/-1.0 mm of Figure 2.1(e)		N/A
J 2.2.3	Internal connections for plug portions	2.9	N/A
	A loose terminal screw or conductive material cannot bridge any live parts or earthing parts;		N/A
	The earthing parts are effectively isolated from contact with a live conductor which may become detached;		N/A
	The live parts are effectively isolated from contact with any earthing conductor which may become detached.		N/A

Cl.	Requirement – Test	Main clause	Verdict
J 2.2.4	Arrangement of earthing connections for plug portions	2.10	N/A
	The earthing pin of any low voltage, three-pin plug shall be that pin which is radial to the circle embracing the pins.		N/A
J 2.2.5	Configuration of plug portions	2.12.6	P
	Configuration of plugs, viewed as from the pins, shall be earth, neutral and active in a clockwise direction. Where there is no earthing pin, the live pins shall conform to this configuration.		P
J 2.2.6	Tests	2.13	P
J 2.2.6.1	General	2.13.1	P
J 2.2.6.2	High voltage test	2.13.3	P
J 2.2.6.3	Mechanical strength of pin tests	2.13.7	P
J 2.2.6.3.1	Tumbling barrel test	2.13.7.1	P
	a) 500 times if the mass of the specimen does not exceed 250g. The pins being straightened after 100 drops and at the completion of the test to pass through the appropriate gauge of figure A1, B1 or F1;		P
	b) 250 times if the mass of the specimen exceeds 250g. The pins being straightened after 25 drops and at the completion of the test to pass through the appropriate gauge of figure A1, B1 or F1;		N/A
	Following each test the samples shall comply with item (e) of clause 2.13.7.1: the pins shall be inspected with normal, or corrected to normal, vision. Insulation may be removed if necessary. Pins shall not be broken or show cracking.		P
J 2.2.6.3.2	Pin bending test	2.13.7.2	P
	All flat pins of plugs rated up to and including 15A shall be tested by clamping the plug in a rigid holding block and applying a bending force, as shown in Figure 2.8, to the pin under test.		P
J 2.2.6.4	Temperature rise test	2.13.8	P
	Test current is specified in the relevant product standard. The temperature rise of the terminals shall not exceed 45 K.		P
J 2.2.6.5	Securement of pins of the plug portion	2.13.9	P
	Movement of pins: clamped 5 ± 0.5 mm and applying 18 ± 1 N to the pin at 14 ± 0.5 mm.	2.13.9.1	P
	The maximum deflection shall not exceed 2.0 mm.		P
	Fixing of pins: maintained $50\pm 2^{\circ}\text{C}$ for 1 h. 60 ± 0.6 N for 10 min.	2.13.9.2	P
	The attachment of pins shall be not more than 2.4 mm or if any pin fails to return to within 0.8 mm of its nominal length specified in Figure 2.1 within 5 min of the removal of the test force.		P

Cl.	Requirement – Test	Main clause	Verdict
J 2.2.6.6	Tests on the insulation material of insulated pin plug portions	2.13.13	P
	Pressure test at high temperature	2.13.13.2	P
	maintained at 160±5°C for 2 h. Force 2,5 N applied through the blade		P
	Thickness within the area of impression ≥ 50 %. no cracks		P
	Static damp heat test	2.13.13.3	P
	Two damp heat cycles in accordance with AS 60068.2.30. Db (12+12h cycle), 95% relative humidity, low temperature 25±3°C and upper temperature 40°C, after this treatment and recovery to room temperature, the specimen subjected to:		P
	(a) the insulation resistance test in accordance with Clause 2.13.2(e);		P
	(b) high voltage test in accordance with Clause 2.13.3 and;		P
	(c) abrasion test in accordance with Clause 2.13.13.6.		P
	Low temperature test	2.13.13.4	P
	Maintained at -15±2°C for at least 24 h and returned to room temperature, the specimen shall be subjected to:		P
	(a) the insulation resistance test in accordance with Clause 2.13.2(e);		P
	(b) high voltage test in accordance with Clause 2.13.3 and;		P
	(c) abrasion test in accordance with Clause 2.13.13.6.		P
	Impact test at low temperature	2.13.13.5	P
	maintained at -15±2°C for at least 24 h. subjected to an impact test by means of the apparatus shown in Figure 2.6, the mass of falling weight be 100±1g , fall from a height of 100 mm. Four impacts. Return to room temperature. No cracks of the insulating material be visible with normal, or corrected to normal, vision without additional magnification.		P
	Abrasion test	2.13.13.6	P
	Plug pins provided with insulating sleeves: 20000 movements, 4 N (apparatus shown in Figure 2.7 No damage, the insulating sleeve shall not have punctured or rucked up.		P

J 2.2.6.7	Equipment with integral pins intended to be supported by the contacts of socket-outlets shall not impose undue strain on those socket-outlets.		P
	The additional torque, which has to be applied to the socket-outlet to maintain the engagement face in the vertical plane, shall not exceed 0.25 N.m.	Positive: 0,018 Nm Reverse: 0,019 Nm	P

Appendix I: Dimension checked by gauge and measurement

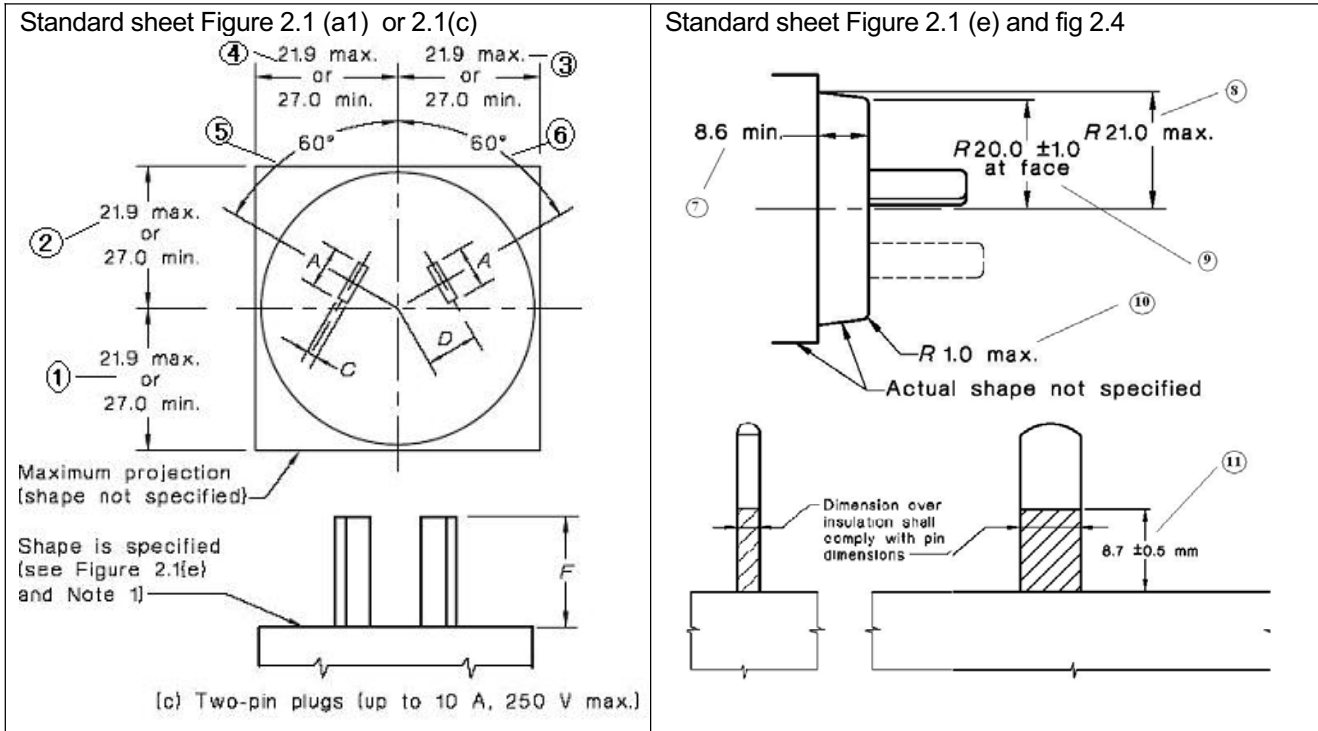

Position	Required (mm)	By Measurement (mm)	By the gauges in Figure A1
A	6.35±0.15	6,29 / 6,35	-
C	1.63 ^{+0.15} _{-0.05}	1,64	-
D	7.92	--	P
F	17.06±0.4	17,02	-
1	21.9 max. or 27.0 min.	42,91	-
2	21.9 max. or 27.0 min.	19,93	-
3	21.9 max. or 27.0 min.	27,48	-
4	21.9 max. or 27.0 min.	27,48	-
5	60°	--	P
6	60°	--	P
7	8.6 min.	9,07	-
8	21.0 max.	19,65	-
9	20.0±1.0	19,47	-
10	1.0 max	<1,0	-
11	8.7±0.5	8,99	-

Dimensions checked by gauge and measurement

Standard sheet Figure 2.1

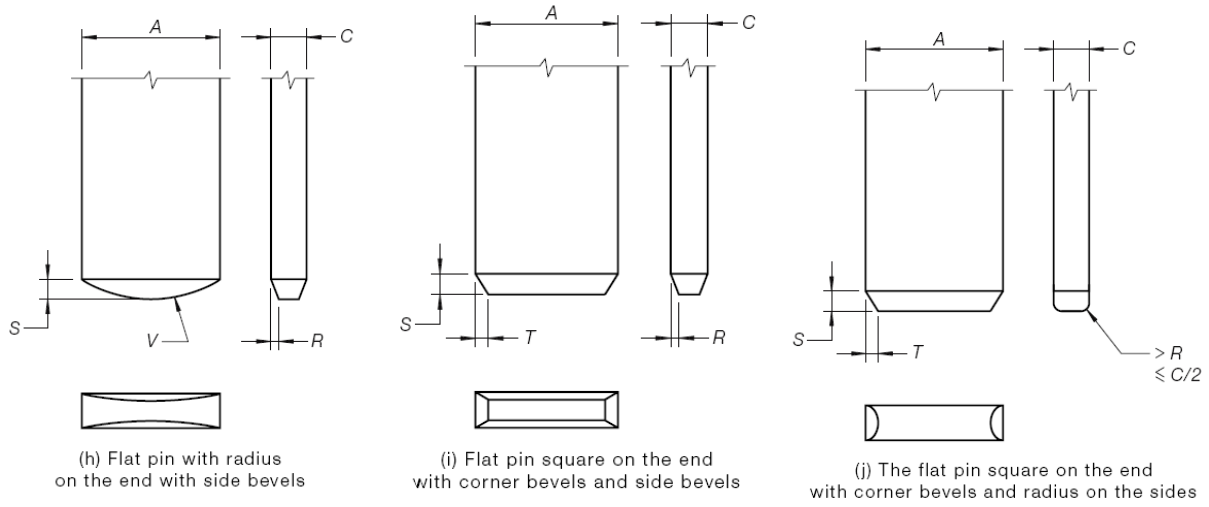

Position	Required (mm)	By Measurement (mm)	By the gauges in Figure A1
Plug type (h)			
R	0.35±0.05	0,31	-
S	0.9±0.1	0,98	-
T	≥0.60	--	-
V	6	--	P