



**Cube Phone with
MP3 Player and FM Radio**

Model: CU328

**USER MANUAL
MANUALE D'USO
MANUAL DO USUÁRIO
MANUAL DE USUARIO**

Cube Phone with MP3 Player and FM Radio

Model: CU328

USER MANUAL

2

CONTENTS

INTRODUCTION	1
Key Features	1
Handset – Front View	2
Handset/Base – Back and Bottom View	3
GETTING STARTED	4
Choosing a Base Unit Location	4
Connecting the Base Unit	4
Battery Set-up	5
Charging Handset Batteries	5
Low Battery Charging	5
Handset Reception	5
Handset LCD Symbols	6
BASIC TELEPHONE FUNCTIONS	6
Switching to Phone Mode	6
Making a Call	6
Answering a Call	7
Ending a Call	7
Call Waiting	7
Message Waiting	7
Adjusting the Speaker Volume	7
Redialing a Call	7
Redialing from the Last 10 Numbers	7
Fast Redial	8
Deleting a Redial Number	8
Saving Dialed Numbers in Memory	8

PHONEBOOK	9
Storing Numbers in the Phonebook	9
Keys to Use	10
Deleting Numbers from Phonebook	10
Editing Numbers in Your Phonebook	11
Calling Numbers from Your Phonebook	11
Quick Browsing of Your Phonebook	11
CALLER ID DISPLAY	12
Viewing Caller ID Records	12
Saving Caller ID Records in Phonebook	12
Deleting Caller ID Records	13
No Caller ID	13
Missed Calls	13
DURING A CALL	14
Using the Mute Function	14
HANDSET SETTINGS	14
Setting the Ring Tone	14
Setting the Ring Tone Volume	14
Setting the Display Language	15
Setting the Dial Tone	15
Setting the Time / Date	15
Setting the Time / Date Format	16
Setting the Alarm	16
Snooze / Turning the Alarm Off	17
Call Waiting	17
Setting the Idle Display	17
CONFERENCE CALLS	18
OPERATING THE BASE UNIT	18
Paging the Handset	18
REGISTERING HANDSETS TO BASE UNIT	18
RESETTING YOUR SYSTEM	19
THE MP3 FUNCTIONS	20

Driver Installation	20
Inserting the SD Card into Your Handset	21
Connecting to Your Computer	21
Disconnecting From Your Computer	22
MP3 BASIC OPERATION	22
Switching to Your MP3 Player	22
Operating Your MP3 Player	22
Play Mode	23
Setting the Sleep Timer	23
EQ Mode	24
Play Time Information	24
Tag Information	25
Volume Control	25
Handling Incoming Calls	25
THE FM RADIO	25
Switching to FM Radio	26
FM Scan Mode	26
Saving a Radio Station	26
Deleting a Radio Station	26
FM Preset Mode	27
Setting the Sleep Timer	27
Volume Control	27
HEADSET JACK	27
SAFETY AND CARE	28
CHANGING THE HANDSET BATTERY	29
TROUBLESHOOTING	29
RECYCLING NICKEL-METAL BATTERIES	30
SPECIFICATIONS	31
ABOUT OREGON SCIENTIFIC	32
DECLARATION OF CONFORMITY	32

INTRODUCTION

Congratulations on your purchase of this Oregon Scientific telephone. Your Cube Phone has been carefully designed and produced by a world leader of consumer electronic equipment

KEY FEATURES

Your Cube Phone with FM radio and MP3 stereo player is a high-quality home communications product with many advanced features, such as:

- Caller ID memory that holds up to 40 numbers.
- Electronic telephone book that holds up to 50 numbers.
- Microphone mute function.
- Adjustable ring tones (including MP3 ring tone), volume levels, language display, handset IDs and low-battery / out-of-range warning signals.
- Rechargeable batteries and up to 7-hours of continuous talk time.
- Support for MP3 and WMA audio file formats
- Multi-format support for mass data storage
- 5 preset equalizer settings
- Multilanguage menu support

IMPORTANT: To use all of the features of this telephone, you must subscribe to either the standard Caller ID service or Caller ID with Call Waiting service from your local telephone company.

The following items should be included in the CU328 package:

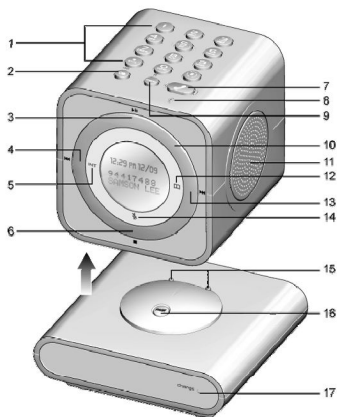

- Base unit
- Telephone audio station
- 1 AC adaptor
- Telephone line cord
- 1 battery
- Battery order sheet
- User manual
- CD-ROM (MP303S) USB driver for Windows98®
- Stereo headset with mic
- USB cable

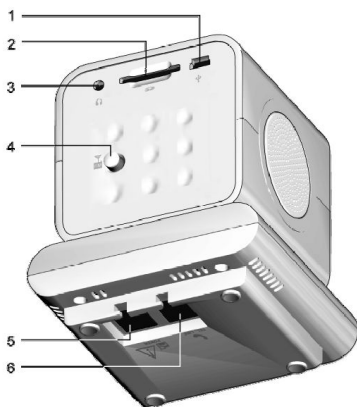

- | | |
|--------------------------------------|-----------------------------|
| 1. Number keys | 13. ►► [FORWARD] key |
| 2. dE /\bullet [DELETE] key | 14. [MUTE] key |
| 3. ► [PLAY / PAUSE] key | 15. Charging prongs |
| 4. ◀◀ [REWIND] key | 16. button |
| 5. INT [INTERCOM] key | 17. Charge/in-use indicator |
| 6. ■ [STOP] key | |
| 7. [TALK] key | |
| 8. [Microphone] | |
| 9. R/^≡ key | |
| 10. Track ring | |
| 11. Speaker | |
| 12. [Address Book] key | |

HANDSET/BASE – BACK AND BOTTOM VIEW



1. **USB** socket
2. **SD CARD** slot
3.  **HEADSET** jack
4.  **Radio antenna**
5. **POWER** jack
6. **TELEPHONE** jack

GETTING STARTED

Certain other communication devices may use the 1.9GHz frequency for communication and, if not set properly, these devices may interfere with your new telephone.

CHOOSING A BASE UNIT LOCATION

When selecting a location for your base unit, please observe the following guidelines:

- Choose a location that provides easy access to an AC power source and telephone jack.
- Do not place the base unit near a sink, bathtub or shower, or close to heat sources.
- Do not place the base unit near large metal objects or electronic appliances that may cause radio interference.

CONNECTING THE BASE UNIT

To connect the base unit:

1. Plug the AC adaptor into the power jack on the bottom of the base, and then plug the other end into an electrical outlet (see below).
2. Plug the telephone line cord into the telephone line jack on the bottom of the base unit, and then plug the other end into your phone jack.

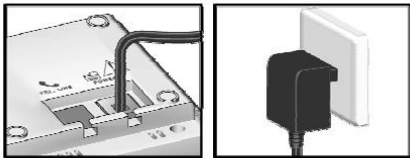

BATTERY SETUP

To install the battery in your handset:

1. Open the battery compartment cover located at the bottom of the handset.
2. Plug the battery connector into the socket.
3. Place battery in the battery compartment.
4. Replace the battery compartment cover by sliding it into place. (The cover clicks into place when it is secured).

NOTE: The handset comes with the battery already installed.

CHARGING HANDSET BATTERIES

You must charge the handset batteries for 15 continuous hours the first time you use them.

When the battery icon in the top right corner on the LCD screen appears empty, or if you hear a warning beep during a call, please:

- End the call as soon as possible.
- Charge the handset by putting it back on the base cradle. (The handset will begin to beep to indicate that the handset is charging).

LOW BATTERY CHARGING

When the battery is low and has only 4 minutes of talk time left, the handset will beep a warning tone and the LCD display will flash "**Low Battery**". When this happens, please end the call as soon as possible, and put the handset back on the charger until the battery symbol returns to high level.







HANDSET RECEPTION

Usually, a loss of reception means you are too far from the base unit, or there is interference between the base unit and handset. Make sure to:

- Stay within a range of 300 meters (984 feet) from the base unit while using the handset.
- Avoid interference such as TV or other electrical appliances.

NOTE: If your handset is out of range of the base unit, the range symbol  starts flashing.

HANDSET LCD SYMBOL

SYMBOL	MEANING
	- Within range indicator - Flashing when out of range
	Ringer is set to off
	Line-in-use
	Missed call
	- Battery (5 levels) - Flashing when battery is low (level 1 )







BASIC TELEPHONE FUNCTIONS

While operating your Cube Phone, if you want to escape from the menu or the current mode, press  _{exit}.

NOTE: The following instructions are for the Phone Mode.



SWITCHING TO PHONE MODE

To change to Phone Mode:

1. Press  , then use  or  to select "Goto Phone".
2. Press  .

NOTE: When you enter the Phone Mode, the telephone icon  will appear at the top of your LCD display.

MAKING A CALL

To make a call, press  to get the dial tone, and then dial the number. (If you make a mistake, press  again to cancel the whole number).

OR

Dial the number, then press .

ANSWERING A CALL

The handset will ring when there is an external call.

To answer a call, press .

To answer a call while music is playing, press . (The audio will pause automatically).

ENDING A CALL

To end a call, simply press .

CALL WAITING

When you hear a call waiting tone, press **R/***  to switch from an existing call, to call waiting.

NOTE: You must subscribe to this service from your local telephone company.

MESSAGE WAITING

When someone has called and left you a message, “**Message Waiting**” will appear on the screen. Follow the voice message commands to access message.

ADJUSTING THE SPEAKER VOLUME

To adjust the speaker volume:



1. Press .
2. Then turn the track ring to adjust the speaker volume accordingly.

REDIALING A CALL

To redial a call, press , and then press **del/** .

REDIALING FROM THE LAST 10 NUMBERS

To redial from the last 10 numbers:

1. Press **del/**  to see your last call record.
2. Use **▶▶**, **◀◀** or the track ring to select a number.
3. Press  to dial the number.

If you want to edit the phone number before redialing:

1. Press **del/◯**.
2. Press **R/*≡**.
3. Use **▶▶**, **◀◀** or the track ring to select **“Edit for Call”**, then press **R/*≡**.
4. Use **del/◯** and 0-9 buttons to edit the number.
5. Press **📞** to dial the number.

FAST REDIAL

When you make a call and hear the busy tone, press **del/◯**. The phone will quickly redial the number within 3 seconds.

DELETING A REDIAL NUMBER

To delete a redialed number:

1. Press **del/◯** to see your last call record.
2. Use **▶▶**, **◀◀** or the track ring to select a number, then press **R/*≡**.
3. Select **“Delete Record”** to delete 1 number, or **“Delete All”** to delete all numbers.
4. Press **R/*≡**.
5. Select **“Yes”**, then press **R/*≡** to confirm.

SAVING DIALED NUMBERS INTO MEMORY

The handset will automatically save the last 10 numbers you dialed.

To save dialed numbers into your phonebook:

1. Press **del/◯**. (The last number is listed).
2. Use **▶▶**, **◀◀** or the track ring to select a phone number, then press **R/*≡**.
3. Select **“Save Phonebook”** to save number, then press **R/*≡**. (“Saved” will appear on the screen to confirm the action).

PHONEBOOK

Your phone can store 50 phone numbers.

STORING NUMBERS IN THE PHONEBOOK

To store a number in your phonebook:

1. Press **R/*≡**.
2. Use **▶▶**, **◀◀** or the track ring to select **"Phone Book"**, then press **R/*≡**.
3. The handset display shows a record or **"—Empty—"**. Press **R/*≡**.
4. Use **▶▶**, **◀◀** or the track ring to select **"Add Record"**.
5. Enter the name (see KEYS TO USE below) and then press **R/*≡**.
6. Enter the phone number and then press **R/*≡**. The handset will beep twice indicating that the record has been stored.

NOTE: If only a phone number and no name is input, then the record can still be saved.

KEYS TO USE

When entering a name, “B” will be entered by pressing the “2” button once, followed by pressing “2” again within 1 second. If pressed beyond 1 second, “A” is entered and the second press of “2” will give the entry of “AA”.

The list of characters is shown below:

	CAPITAL LETTERS	SMALL LETTERS
1	SPACE 1 _ - + = ^ ~ . , ; : ? !	SPACE 1 _ - + = ^ ~ . , ; : ? !
2	ABC2Ä/ÆAAAÄÄÄÇ	abc2äæåääääç
3	DEF3ÈÉÊËËË	def3èéêëë
4	GHI4ÌÍÏ	ghi4ìíï
5	JKL5	jkl5
6	MNO6ÖØÓÓÓÕÑ	mno6öøóóóõñ
7	PQRS7	pqrs7
8	TUV8ÙÚÛÜ	tuv8ùúûü
9	WXYZ9ÝÞ	wxyz9ýþ
0	0 * # \$ & % / \ () [] < >	0 * # \$ & % / \ () [] < >
*	Press when editing a name to return to Standby Mode. Press when editing a number to get “*”.	
#	Press to change between capital and small letters.	

DELETING NUMBERS FROM PHONEBOOK

To delete a record in your phonebook:

1. Press **R/***.
2. Use **▶▶**, **◀◀** or the track ring to select “**Phone Book**”, then press **R/***.
3. The handset display shows a record. Use **▶▶**, **◀◀**, or the track ring to select the record you want to delete. Press **R/***.
4. Use **▶▶**, **◀◀** or the track ring to select “**Delete Record**”.
5. Press **R/***.

6. Select **Yes** to complete deletion. The handset will beep twice indicating that the record has been deleted.

To delete all records:

1. Follow steps 1-4 above and select **Delete All?**
2. Now follow steps 5-6 above.

EDITING NUMBERS IN YOUR PHONEBOOK

To edit a record in your phonebook:

1. Press **R/***.
2. Use **▶▶**, **◀◀** or the track ring to select **Phone Book**, then press **R/***.
3. Press **R/*** again, and then use **▶▶**, **◀◀** or the track ring to select **Edit Record**.
4. Press **R/***. Use **del/◯**, 0-9 and **▶▶**, **◀◀** to edit the name. (See KEYS TO USE section) and then press **R/***.
5. Use **del/◯** to edit the number and then press **R/***. The handset will beep twice indicating that the record has been stored.

CALLING NUMBERS FROM PHONEBOOK

To call using a number in your phonebook:

1. Press **R/***.
2. Use **▶▶**, **◀◀** or the track ring to select **Phone Book**, then press **R/***.
3. Use **▶▶**, **◀◀** or the track ring to select a number, then press  to dial the number.

QUICK BROWSING OF YOUR PHONEBOOK

To browse through your phonebook quickly:

1. Press **□** and then use **▶▶** or **◀◀** to browse through your phonebook.
2. Then press the key with the 1st letter of the person's name you are looking for. (For example, press key 7, 4 times to get quick access to a name beginning with 'S').

Press  to dial the selected number, or press ***_{exit}** to return to Standby Mode.

NOTE: You can use the phonebook function while on an active call.

CALLER ID DISPLAY

If you have subscribed to this service, the caller's phone number will display when there is an incoming call.

NOTE: If the caller's phone number was stored in the phonebook, the associated name will be displayed with the phone number.

Each entry in the caller list has the:

- Caller number (up to 24 digits)
- Caller name (up to 15 characters)
- Date and time of the call
- Number of calls made to this number (up to 40).

VIEWING CALLER ID RECORDS

To view caller ID records:

1. When the phone is in Standby Mode use the track ring to browse through Caller ID records.
2. If you need to edit the phone number before making the call press **R/*≡**.
3. Use **▶▶**, **◀◀** or the track ring to select **"Edit for Call"**.
4. Use **dEI/○●** and 0-9 buttons to edit the number.
5. Press **📞** to dial the number.

NOTE: If **"No Calls"** appears on the screen, then no records are stored in the Caller ID memory.

NOTE: When the Caller ID memory is full, it will automatically delete your 1ST Caller ID record.

SAVING CALLER ID RECORDS IN YOUR PHONEBOOK

When you have a Caller ID record on your screen:

1. Press **R/*≡**, then use **▶▶**, **◀◀** or the track ring to select **"Save Phonebook"**.
2. Press **R/*≡** **"Saved"** will appear on the screen to confirm the action.

DELETING CALLER ID RECORDS

To delete a record:

1. Press the track ring whilst in Standby Mode and select the number you want to delete. Then, press **R/*≡**.
2. Select **"Delete Record"**, then press **R/*≡**.
3. Select **"Yes"**, then press **R/*≡** to confirm.

To delete all records:

1. Press **▶▶, ◀◀** or the track ring whilst in Standby Mode. Then, press **R/*≡**.
2. Select **"Delete All"**, then press **R/*≡**.
3. Select **"Yes"**, then press **R/*≡** to confirm.

NO CALLER ID

If a caller has withheld their Caller ID name and / or number, one of the following messages will appear on your screen:

- **"Blocked Number"**
- **"Unknown Number"**
- **"Blocked Name"**
- **"Unknown Name"**
- **"Unknown Caller"**
- **"Blocked Call"**

MISSED CALLS

If you miss a call, the handset will display: .

When you view the Caller ID of your missed calls, the following notifications will appear on the screen:

- **"NEW"** – This is the first missed call from this particular Caller ID.
- **"REPT"** – This appears when more than one call has been missed from this particular Caller ID.

DURING A CALL





USING THE MUTE FUNCTION

To mute the handset, press .

To un-mute the handset, press  again. You will return to the normal mode.

HANDSET SETTINGS

IMPORTANT:







- If you press  the button, you will enter Talk Mode.
- If you press **R/***  the button, you will enter Menu Mode.
- You cannot enter the Menu Mode when the phone is in Talk Mode. To exit the Talk Mode press .
- To leave a setting at any time and return to Standby Mode, press the  button.

NOTE: When you have completed a setting, 2 beeps will sound to indicate that the task is complete.

SETTING THE RING TONE

You have a choice of 10 polyphonic melodies, 4 tones and MP3 songs for incoming calls.

To select a ring tone:

1. Press **R/*** , then use   or the track ring to select "Sound & Display".
2. Press **R/*** .
3. Select "**Ringer Tone**", then press **R/*** .
4. Select the melody or tone you prefer, then press **R/***  to confirm.
You will hear a demonstration of the tone/song selected.

SETTING THE RING TONE VOLUME

To set the ring tone volume:

1. Press **R/*** , then use, or the track ring to select "**Sound & Display**".

2. Press **R/*≡**, then use, or the track ring to select **“Ringer Volume”**.
Then press **▶▶** or **◀◀** to confirm.
3. Use **▶▶**, **◀◀** or the track ring to increase or decrease the volume.
4. Then press **R/*≡** to confirm.

NOTE: If the ring volume is turned off, you will see the  icon.

SETTING THE DISPLAY LANGUAGE

To change the language:

1. Press **R/*≡**, then use **▶▶**, **◀◀** or the track ring to select **“Phone Setup”**.
2. Press **R/*≡**, then use **▶▶**, **◀◀** or the track ring to select **“Language”**, then press **R/*≡**.
3. Select the language you want, then press **R/*≡** to confirm.

NOTE: The default language for the handset display is English. You can also change the language to French, Spanish, German, Italian, Dutch, Portuguese, Swedish, Finnish, Danish or Norwegian.

SETTING THE DIAL TONE

In order to provide compatibility with other phone systems, your phone can be set to either Pulse dialing (same as rotary dial phones), or Tone dialing (DTMF).

To set the Dial Mode:

1. Press **R/*≡**, then use **▶▶**, **◀◀** or the track ring to select **“Phone Setup”**.
2. Press **R/*≡**, then use **▶▶**, **◀◀** or the track ring to select **“Dialing”**.
3. Press **R/*≡**.
4. Select either **“Tone”** or **“Pulse”** mode, then press **R/*≡** to confirm.

SETTING THE TIME/DATE

To set the time / date format:

1. Press **R/*≡**, then use **▶▶**, **◀◀** or the track ring to select **“Clock & Timer”**.
2. Press **R/*≡**.

3. Select **"Date & Time"**, then press **R/*≡**.
4. Select **"Set Time"** or **"Set Date"**, then press **R/*≡**.
5. Use the number keys to set the time/date. (Use **▶▶**, **◀◀** to select hour or minutes to set).
6. Press **R/*≡** to confirm.

SETTING THE TIME/DATE FORMAT

To set the time / date format:

1. Press **R/*≡**, then use **▶▶**, **◀◀** or the track ring to select **"Clock & Timer"**.
2. Press **R/*≡**.
3. Select **"Date & Time"**, then press **R/*≡**.
4. Select either **"Time Format"** or **"Date Format"**, then press **R/*≡**.
5. Use the number keys to set the **Time/Date Format**.
6. Press **R/*≡** to confirm.

SETTING THE ALARM

Your Cube Phone comes with dual alarm functionality.

To set the alarm:

1. Press **R/*≡**, then use **▶▶** or **◀◀** to select **"Clock & Timer"**.
2. Press **R/*≡**.
3. Select **"Alarms"**, then press **R/*≡**.
4. Select **Alarm1** or **Alarm2**, then press **R/*≡**.
5. Use the number keys to set the alarm time.
6. Press **R/*≡** to confirm.

NOTE: You can select Alarm Tone 1, 2, 3, 4 or radio.

NOTE: The alarm will be set automatically upon confirmation.

SNOOZE / TURNING THE ALARM OFF

Once an alarm sounds, you may, press any key once and the alarm will snooze for 8 minutes.

OR



Press and hold  to turn off the alarm.

NOTE: If no button is pressed for 2 minutes the alarm will turn itself off.

CALL WAITING

If an external call comes in during an intercom conversation, you will hear a call waiting tone.





To end an intercom call:

1. Press . (The external line will ring).
2. Press  again to answer the external call.

SETTING THE IDLE DISPLAY

The idle display shows the phone status and time on your LCD Display during phone standby.

To set your idle display:

1. Press **R/*** , then use **▶▶**, **◀◀** or the track ring to select **“Sound & Display”**.
2. Press **R/*** , then use **▶▶**, **◀◀** or the track ring to select **“Idle Display”**.
3. Press **R/*** .
4. Select **“Phone Status”** or **“Digital Clock”** then press **R/***  to confirm.

NOTE: It will take 12 minutes for the idle display to be activated after confirmation.

CONFERENCE CALLS

You can have a conference call with an external party and 2 internal parties.

To have a conference call:

1. First establish the call with the external party by either making an external call or answering an incoming call.
2. Press **INT** to make an intercom call to another handset. (The external party will be put on hold. The internal party answers your intercom call by pressing ).
3. Then you press **(#)** and hold for about 2 seconds (you will hear a confirmation key tone).

You, the external party and the other internal party can talk together in a conference call.

OPERATING THE BASE UNIT

PAGING THE HANDSET

To look for your handset, press the  button in the cradle of the base unit.

To stop the paging, press any button once.

REGISTERING HANDSETS TO BASE UNIT

The handset and base unit are factory pre-registered with each other. When you purchase an additional handset, you have to register it to the base unit in order to make and answer calls.

You can register up to 4 more handsets to make and answer calls via the same base unit. Handsets are numbered 1 to 4.

To register a new handset:

1. Press and hold the  button on the cradle of the base unit to enter Registration Mode.
2. On the handset, press **R/*≡**.
3. Use **▶▶**, **◀◀** or the track ring to select **"Phone Setup"**, then press **R/*≡**.

- 
4. Select **Registration**, then press **R/***.
 5. Use **▶▶**, **◀◀** or the track ring to select **Base 1, 2, 3 or 4**, then press **R/***.
 6. Enter the default Pin Code **0000** then press **R/***.
 7. You will see the message: **Registering**.
 8. When the registration is complete, **Registration Success** will appear on the screen.

NOTE: The base unit will then send a signal to the handset registering the handset to the base unit. Once the registration function has been completed, the handset will return to Standby Mode.

RESETTING YOUR SYSTEM

To reset your system to the default settings:

1. Press **R/***, then use **▶▶** and **◀◀** to select **Phone Setting**.
2. Press **R/***.
3. Select **Set Default**, then press **R/***.
4. When prompted, select **Yes**. You will then hear the double beep to indicate the default settings have been restored.

Your default settings are:

- Language: English
- **INT** melody: Melody 1
- Handset name: Handset
- Ring volume: 3
- Dial mode: Tone
- Battery indicator: On
- Ear /Speaker volume: 1
- Range indicator: On

THE MP3 FUNCTIONS

Your CU328 comes with a built-in MP3 player, which supports multiple audio standards, such as WMA (Windows Media Audio™ Version 8) and MP3 formats. You can also transfer files easily via a USB2.0 TM connection.

Please ensure your computer meets the following minimum system requirements:

- Intel® Pentium® 133MHz or faster
- CD-ROM Drive
- USB1.1 port or USB2.0 port
- 10MB free hard disk space
- Microsoft® Windows®, 98SE, ME, 2000 or XP
- Mac OS 9.0 or above

NOTE: WMA data bit rates lower than 22kbps are not supported by the CU328.

DRIVER INSTALLATION

Windows® ME, 2000, XP Users

Windows® already provides the USB driver.

Windows 98SE Users

Installing the MP3 driver software is necessary.

To install the MP3 driver software:

1. Insert the MP3 CD-ROM into your computer.
2. Follow the on-screen instructions.
3. Restart your computer.

INSERTING THE SD CARD INTO HANDSET

The SD card stores files downloaded from your computer via the USB cable.

To insert the SD card into your handset:

1. Locate the SD socket at the back of the handset, and insert the SD card with the “clipped” corner on the top right.
2. Push the SD card into the socket all the way. (You will hear a click; this indicates that the card is in place).

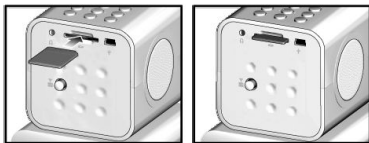

To remove the SD card from the handset:

1. Push the SD card inwards until you hear the clicking sound that indicates that it will self-eject.
2. Pull the SD card from the slot.

NOTE: The SD card capability is from 32MB to 1GB.

NOTE: Any songs you downloaded from your computer while the SD card was inside your handset will be stored in your SD card. Therefore make sure you protect the SD card from moisture and damage.

CONNECTING TO YOUR COMPUTER

Insert the USB cable to the USB port in your PC and connect the mini-USB connector to your USB port. The unit will automatically begin charging.

IMPORTANT: Do not disconnect while downloading data from your PC.

DISCONNECTING FROM YOUR COMPUTER

Please follow the procedures below.

For Windows 98SE:

1. Double click the **My Computer** icon.
2. Right click the removable drive letter your player has been assigned.
3. Click “Eject” from list before disconnecting.

For Windows ME, 2000, XP:

Before disconnecting, click the “Stop USB Mass Storage Device”  icon on the Windows taskbar at the bottom right of your computer screen to stop the device.

For Macintosh:



Drag and drop the “Untitled” icon from the desktop to the “Trash” icon to eject the player before disconnecting.

NOTE: Before unplugging your player from your computer, wait at least 15 seconds after the audio or data file transfer is completed to prevent any data loss that may occur.

MP3 BASIC OPERATION

SWITCHING TO YOUR MP3 PLAYER

To switch to MP3 Mode:

1. Press **R/*** , then use **▶▶** or **◀◀** to select “**Goto MP3**”.
2. Press **R/*** .

NOTE: The MP3 player functionality will not work unless you have inserted the SD card into the SD socket at the back of the handset.

NOTE: To escape from the menu or the current mode, press ***_{exit}**.

OPERATING YOUR MP3 PLAYER

The operation of your MP3 player is simple and intuitive.

To play a song, while in the MP3 Mode, press **▶||**.

To stop a song, press **■**. (This button is at the bottom of the silver volume ring).

To pause a song, press ►||.

To fast forward through a track, press and hold ►►. If you want to skip more than the current track, press and hold the ►► button.

To rewind to a previous track, press and hold ◀◀. If you want to rewind back to more than the previous track, press and hold the ◀◀ button.

PLAY MODE

You have a number of choices of how to play your songs, including:

- **Repeat All** – Plays all audio files over and over in chronological order.
- **Repeat One** – Plays the selected audio file continuously.
- **Random Repeat** – This setting will repeat randomly selected audio files.
- **Random** – Plays audio files that are selected randomly.
- **Normal** – Plays all audio files in chronological order.

To switch to Play Mode while in MP3 Mode:

1. Press R/⊞.
2. Use ►►, ◀◀ or the track ring to select “Play Mode”.
3. Press R/⊞.
4. Once you are in Play Mode, simply use ►►, ◀◀ or the track ring to select the mode of your choice.
5. Once you have selected, press R/⊞.

SETTING THE SLEEP TIMER

The Sleep Timer is designed to automatically shut off audio after a certain period of time. (This feature enables you to fall asleep with the music on without having it play all night).

To set the sleep timer function:

1. Press R/⊞.
2. In the MP3 Mode (or Radio Mode), use ►►, ◀◀ or the track ring to select “Sleep Timer”, then press R/⊞.
3. Use ►►, ◀◀ or the track ring to select a timer setting, then press R/⊞. (2 beeps will sound to confirm selection).

EQ MODE

You have a number of choices of how to equalize your music, including:

- **Classic** – Affects sound to enhance all classical music.
- **Live** – Affects sound to enhance all live music.
- **Pop** – Affects sound to enhance pop music.
- **Rock** – Affects sound to enhance rock music.
- **Normal** – No audio settings set to enhance sound.

To switch to EQ Mode while in MP3 Mode:

1. Press **R/⏏**.
2. Use **▶▶**, **◀◀** or the track ring to select “**EQ Mode**”.
3. Press **R/⏏**.
4. Once you are in EQ Mode, simply use **▶▶**, **◀◀** or the track ring to select the mode of your choice.
5. Once you have selected, press **R/⏏**.

PLAY TIME INFORMATION

You have two choices of how to display your play time information, which include:

- **Elapse** – Shows time passed since beginning of audio file.
- **Remain** – Shows time to play until audio file finishes.

To switch to Play Time Information Mode while in MP3 Mode:

1. Press **R/⏏**.
2. Use **▶▶**, **◀◀** or the track ring to select “**Play Time Info**”.
3. Press **R/⏏**.
4. Once you are in Play Time Info Mode, simply use **▶▶**, **◀◀** or the track ring to select the time display of your choice.
5. Once you have selected, press **R/⏏**.

TAG INFORMATION

You have two choices of how to tag your files in your MP3 player: ON or OFF.

To switch to Tag Info Mode while in MP3 Mode:

1. Press **R/***.
2. Use **▶▶**, **◀◀** or the track ring to select **"Tag Info"**.
3. Press **R/***.
4. Once you are in Tag Info Mode, simply use **▶▶**, **◀◀** or the track ring to select **"On"** or **"Off"**.
5. Once you have selected, press **R/***.

VOLUME CONTROL

To adjust the volume, move the track ring clockwise to increase the volume, or counter-clockwise to decrease the volume.

HANDLING INCOMING CALLS

When there is an incoming call while the user is listening to the MP3 or Radio, the Cube Phone will pause playing automatically.

To receive an incoming call while music is on, press .

After the call ends, your Cube Phone will return to the MP3 or FM Mode.

THE FM RADIO (87.5 – 108MHz)

You can preset up to ten radio stations in your telephone. Pull out the antenna located at the back of the handset to maximize your reception).



SWITCHING TO FM RADIO

To switch to the FM Mode:

1. Press **R/⏏**, then use **▶▶**, **◀◀** or the track ring to select **“Goto FM”**.
2. Press **R/⏏**.

NOTE: When you enter the FM Mode, the radio icon  will appear at the top of your LCD display.

FM SCAN MODE

To get to the FM Scan Mode while in FM Mode:

1. Press **R/⏏**.
2. Use **▶▶**, **◀◀** or the track ring to select **“FM Scan Mode”**.
3. Press **R/⏏**.
4. Once you are in FM Scan Mode, simply use **▶▶** or **◀◀** to find a FM station, or press and hold **▶▶** or **◀◀** to search automatically for a FM station with good reception.

SAVING A RADIO STATION

To save a radio station:

1. Press **R/⏏**.
2. Use **▶▶**, **◀◀** to select **“Save Stations”**.
3. Press **R/⏏**.
4. Once you are in Save Stations Mode, simply use **▶▶** or **◀◀** to select a channel from a list of ten stations (channels).
5. Press **R/⏏** to save the selected radio station.

DELETING A RADIO STATION

To delete a radio station:

1. Press **R/⏏**.
2. Use **▶▶**, **◀◀** to select **“Delete Stations”**.
3. Press **R/⏏**.
4. Use **▶▶** or **◀◀** to select a channel from the list of ten stations (channels).

5. Press **R/☰** to delete the selected station.

NOTE: The deleted radio station will disappear from the list, but when you enter the “Save Stations” Mode, the channel will be listed but will show “—Empty—”.

FM PRESET MODE

To get to the FM Preset Mode while in FM Mode:

1. Press **R/☰**.
2. Use **▶▶**, **◀◀** to select “**FM Preset Mode**”.
3. Press **R/☰**.
4. Once you are in FM Preset Mode, simply use **▶▶** or **◀◀** to select a preset radio station from the list of ten stations (channels). The radio will then play.

NOTE: The LCD display will show the channel number under the word “**Preset**”.

SETTING THE SLEEP TIMER

Please see SETTING THE SLEEP TIMER in the MP3 BASIC OPERATIONS section of this manual.

VOLUME CONTROL

The volume works the same way as for the MP3 player. (See VOLUME CONTROL in the MP3 BASIC OPERATIONS section).

HEADSET JACK

A headset can be used with your telephone for hands-free conversation.

To use a headset, plug it into the HEADSET jack located at the back of the handset.

While the headset is connected, press  to answer or place a call.

NOTE: The headset is worn with the strap around the back of the head, not around the top of the head.

SAFETY AND CARE

This product is designed to give you years of service if handled properly. Please observe the following guidelines:

- Do not subject the main unit to extreme force, shock or fluctuations in humidity.
- Do not make any changes or modifications to this product. (Unauthorized changes may void your right to use the product).
- Keep your player away from any strong magnetic fields. Exposure to magnetic fields may cause the memory to be erased or even damaged.
- Do not expose your telephone to direct sunlight or moisture.
- Clean the phone with a soft cloth, but never use a strong cleaning agent or abrasive powder. This will damage the finish.
- Periodically clean the charge contacts on the handset and base unit with a clean pencil eraser.

FM RADIO

Causes of poor reception:

- Aluminum siding
- Foil backing on insulation
- Heating ducts and other metal construction shielding radio signals
- You are too close to appliances, such as microwaves, stoves or computers
- Atmospheric conditions, such as strong storms
- The unit is installed in the basement or lower floor of the house
- Base unit is plugged into an AC outlet with other electronic devices
- Handset battery is low
- You are out of the transmission range

NOTE: If you are having poor reception, be sure to pull out the antenna at the back of the unit.

CHANGING THE HANDSET BATTERY

When the handset operating time becomes short even after a battery has been recharged, please replace the battery. With normal usage, your battery should last about one year.

REPLACING THE BATTERY

1. Make sure the telephone is turned OFF.
2. Slide off the battery compartment cover.
3. Disconnect the battery plug from the jack in the compartment and remove the battery pack.
4. Insert the new battery pack and connect the cord into the jack.
5. Put the battery compartment cover back on.
6. Place handset on the base to charge the new battery for 15 hours.

CAUTION: To reduce the risk of fire or personal injury, use a 3.6 V, 1200mAh battery. Contact your place of purchase.

TROUBLESHOOTING

If your Cube Phone is not working correctly, check the points here before returning it for repair.

Whatever your issue, you should first check that:

- You have installed the Base Unit correctly, and it is plugged into the telephone line and the main power socket.
- Main power is switched on at the socket.
- You have installed the batteries into the handset.

NEVER attempt any repairs or adjustments yourself - you could make the issue worse and invalidate your guarantee.

POTENTIAL ISSUES

Problems with making and answering calls:

“I have tried several times to press  but I cannot make a call”

- Unplug the power adapter at the bottom of the Base Unit, then reconnect the power adapter. Press and hold **PAGE** on the Base Unit until **IN**

USE (green LED) is flashing.

“The Caller Display function is not working”

- Please check if you have subscribed to the Caller Display service with your network provider.

“My call was cut off when I went out of range of the Base Unit. Now I cannot use my handset.”

- Please move the handset closer to the Base Unit.

“The handset does not ring when a call comes in.”

- Check that you have not set the ringing volumes to “off”.

RECYCLING NICKEL-METAL HYDRIDE BATTERIES

Nickel-metal hydride batteries must be disposed of properly.



Please take your used battery pack to a store that recycles Ni-MH batteries.

SPECIFICATIONS

Here are the specifications for your Cube Phone:

TYPE	DESCRIPTION
Standard	WDCT for US DECT for Europe
Frequency range	2.4GHz ISM for US 1880 to 1990MHz for Europe
Channel bandwidth	864MHz for US 1.728MHz for Europe
Modulation	GFSK
Speech coding	Adaptive Differential Pulse Code Modulation (ADPCM)
Communication range	Up to 300 metres (984 feet) in open space
Base power supply	Input: AC 120V/60HZ for US Output: 9V 200mA / 9V DC 400mA for US Input: AC 220-230V/50HZ for Europe Output: 9V AC 200mA / 9V DC 400mA for Europe
Handset power supply	1 rechargeable battery, NiMH AA 3.6V 1200mAh
Handset battery charging time	15 hours (approx.)
Operating time	Standby: 5 days (approx.) Talk: 7 hours (approx.)
Operating temperature	0°C to 45°C
Storage temperature	-20°C to 60°C
Weight	Handset: 335g (11.8 ounces); Base unit: 120g (4.2 ounces)
Dimensions	Handset: 80 x 80 x 80mm (3.2 x 3.2 x 3.2inches) Base unit: 92 x 98 x 37.8mm (3.6 x 3.9 x 1.5inches)

NOTE: The technical specifications for this product and the contents of the user guide are subject to change without notice.

ABOUT OREGON SCIENTIFIC

Visit our website (www.oregonscientific.com) to learn more about Oregon Scientific products such as digital cameras; MP3 players; children's electronic learning products and games; projection clocks; health and fitness gear; weather stations; and digital and conference phones. The website also includes contact information for our Customer Care department in case you need to reach us, as well as frequently asked questions and customer downloads.

We hope you will find all the information you need on our website, however if you're in the US and would like to contact the Oregon Scientific Customer Care department directly, please visit:

www2.oregonscientific.com/service/support

OR

Call 1-800-853-8883.

For international inquiries, please visit:

www2.oregonscientific.com/about/international/default.asp

DECLARATION OF CONFORMITY

"Hereby, **Oregon Scientific** declares that this Cube Phone (CU328) is in compliance with the essential requirements and other relevant provisions of Directive 1999/5/EC. A copy of the signed and dated Declaration of Conformity is available on request via our Oregon Scientific Customer Service."



COUNTRIES RTTE APPROVAL COMPLIED

All EC countries, Switzerland 

and Norway 