



**Dear Customer,**

Thank you for purchasing the ATC5K by Oregon Scientific.

At Oregon Scientific, we understand that action, outdoor and adventure sports enthusiasts as well as everyday enthusiasts take great pride and satisfaction in recording and viewing first person footage captured by our hands free action cam.

For this reason, the ATC5K was designed and engineered with extreme precision, in order to allow you to Take The Adventure Home With You.

Review the following pages for technical information, tips and troubleshooting which will allow you to maximise your experience with the ATC5K.

**PLAY HARD, RECORD EVERYTHING.**

OREGON SCIENTIFIC and associated trademarks and trade dress are owned by OREGON SCIENTIFIC, Inc.  
© 2008 OREGON SCIENTIFIC, Inc. All Rights Reserved.

## Oregon Scientific ATC5K

- I . Quick Start .....1**
- II . Camera Precautions .....1**
- III . Technical Specifications .....3**
- IV . Computer System Requirements .....3**
- V . Camera Description .....4**
- VI . Camera Mounting Description .....5**
- VII . Camera Usage .....6**
  - Battery Installation .....6**
  - Turning On/Off the Camera .....7**
  - Inserting/Removing the SD Card .....7**
  - Taking Video Footage .....8**
- VIII . Menu Settings .....9**
  - Playback on LCD .....11**
  - Resolution .....11**
  - Privacy Mode .....12**
  - Sound Recording .....12**
  - Setting Date/Time .....12**
  - Deleting individual files .....13**
  - SD Memory Card .....13**
- IX . Connecting to a computer .....14**
- X . Webcam installation .....15**
- XI . Webcam / USB mode .....24**
- XII . Playing back video footage on a TV .....25**
- XIII . Troubleshooting .....26**





## I) Quick Start

### Turning the Camera On

Press and hold the On/Off button for 2 seconds (one beeping sound). The LCD screen will show the remaining time and the LED will be green.

### Taking Video Footage

1. Aim at what you want to record.
2. Press and hold the 'Movie shutter button'  for 2 seconds to start recording (one beeping sound). The time elapsed will be shown on the LCD screen and the LED will go from green to red.
3. Press and hold the 'Movie shutter button'  again for 2 seconds to stop recording (two beeping sounds). The length of the video footage will show on the LCD screen for 2 seconds, after which the remaining time will be shown (the remaining time is an estimate only) and the LED will go from red to green.

### Capturing Photos

1. Aim at what you want to capture a photo of.
2. Press the 'Photo capture button' .
3. The screen will show the number of photos on memory (the number of photos on memory is an estimate only).

## II) Camera Precautions

### Notice the following guidelines when using your camera

- The ATC5K is shock resistant, not shock proof.
- For your safety, do not press the buttons on the camera during sports activities.
- Do not place the camera in areas prone to dust or damp for extended periods of time. This may cause a fire or an electrical shock.
- Do not leave the camera in places exposed to extremely high temperatures, such as under direct sunlight, for extended periods of time. This may affect the camera housing and internal components.
- Clean the lens with a soft cloth to remove fingerprints or dust.
- We recommend using Alkaline batteries in temperatures between 32°F to 104°F (0°C to 40°C).
- The working temperature range of a normal Alkaline AA battery is 32°F to 104°F (0°C to 40°C). Above or below this temperature may cause the batteries to malfunction, therefore for use in low temperature, we recommend changing to Lithium batteries.
- Turn the camera off before removing the batteries or memory card. The card and the data may be damaged if the memory card is inserted or removed while the camera is still on.
- Remove the batteries and memory card before storing the camera for long periods of time. Keep it in a well-ventilated place to prevent mould.
- Under the following circumstances, have the camera repaired by qualified personnel:
  - a) The plug is damaged or worn.
  - b) The device has been dropped and/or the housing has been damaged.
  - c) Liquid has entered the camera.

**Disclaimer:** Oregon Scientific will not, under any circumstances, be responsible for injuries or property damage incurred during participation of any high-risk sport/activity not endorsed or recommended by Oregon Scientific. Should the camera malfunction under these circumstances, it would not be covered by the warranty. The warranty will cover manufacturing defects.

**Notes on copyright:** Users are asked to note that the transfer of memory containing photos or data protected under copyright laws is only permissible within the restrictions imposed. Users assume all responsibility in the event that copyrights are violated by the use of this camera.

### Waterproof Feature

The ATC5K camera is waterproof up to 3m (10ft). Oregon Scientific will not assume any responsibility for camera malfunction caused by liquid entering the camera as a result of misuse by the user.

### Important:

The remote control is not waterproof, it is water resistant. Do not take it underwater as it may malfunction.

### Precaution:

Ensure the latch above the LCD screen is correctly and completely locked to keep liquid out of the camera.

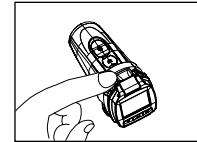

### Liquid may get inside the camera if the latch is not locked properly

- If the camera gets wet, wipe the liquid off as soon as possible with a dry cloth.
- Other camera accessories may not be waterproof.
- Ensure the latch above the LCD screen is correctly and properly locked.

### Using the camera in cold weather

- We recommend using Energizer e2 lithium batteries in cold weather.

### Don't use the camera in extreme temperatures as this may cause the camera to malfunction.

### Attention:

- Non-rechargeable batteries are not to be recharged;
- Rechargeable batteries are to be removed from the camera before being charged;
- Rechargeable batteries are only to be charged under adult supervision;
- The supply terminals are not to be short-circuited;
- Exhausted batteries are to be removed from the camera.

### III) Technical Specifications

- Sensor resolution 640x480 VGA CMOS sensor
- Built-in memory 32MB
- SD memory card drive supports cards of up to 4GB (not included)
- Movie storage:
  - 640 x 480 pixels (30\* frames per second)
  - 320 x 240 pixels (30\* frames per second)
- Photo capture:
  - 640 x 480 pixels
- 1.5" Colour TFT LCD
- Focussing range 3m~infinity
- Movie images AVI
- File format of Interface USB (1.1)
- Delete image All / last one
- Auto Shut-Off 30 minutes
- Battery 2 x 1.5V AA alkaline batteries (included)
- Dimensions 113mm x 54mm x 50mm
- Operating system Win 2000/XP/Vista and Apple Mac X 10.4 and below

### IV) Computer System Requirements

#### Minimum System Requirements

- Pentium III 800 MHz or higher
- Windows 2000, Windows XP, Windows Vista and Apple Mac X 10.4 and below
- 128 MB RAM
- 800 MB Free hard disk space
- SVGA 800 x 600 resolution video support (32 bit)
- 16 bit Windows compatible sound device

\* In some cases, the frame rate may be automatically reduced to maximise the memory usage.

### V) Camera Description

1. Lens
2. 2 colour LED and IR receiver
3. Camera grip
4. Screw
5. Nut
6. Handlebar grip
7. Helmet grip
8. USB cable
9. AV cable
10. Rubberised patch
11. Velcro patch
12. Short velcro strap
13. Long velcro strap
14. Silicon rubber head strap
15. Bolt
16. Mount lock and tripod mount

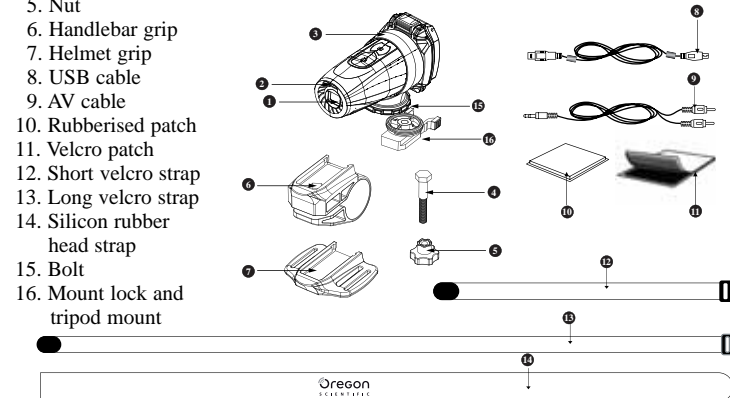

17. Webcam stand
18. Webcam installation CD
19. LCD screen
20. ON/OFF
21. Confirm button
22. Menu button & Select button
23. Movie shutter button
24. Photo capture button
25. Battery door
26. Batteries (included)
27. Mini-USB port
28. SD card slot
29. SD card (not included)
30. AV port
31. Remote Control
32. Camera carry bag

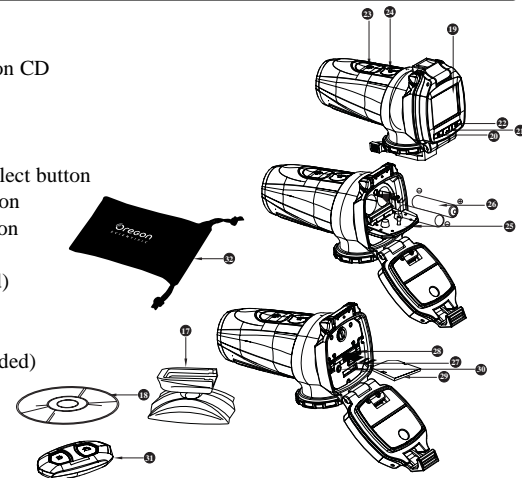

EN

## VI) Camera Mounting Description

The camera can be mounted in a number of ways using the straps and the velcro patch provided. Please follow the methods of mounting as suggested below:

### Fixing the position of the camera

- With the base of the camera facing you, turn the clip clockwise to tighten its position.
- With the base of the camera facing you, turn the clip counter clockwise to loosen its position.

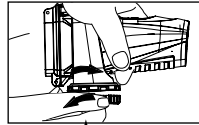

**Note:** Use caution when twisting; the clip may be sharp.

### Mounting the camera onto a helmet using the silicon rubber strap:

- Attach the rubberised patch to the bottom of the helmet mount grip.
- +3. Thread the silicon rubber strap through the helmet grip.
- Mount the helmet grip to the helmet using the silicon rubber strap.
- Slide the camera into the helmet mount grip.
- Adjust the angle of the camera making sure it's secure.
- If the camera seems loose when the helmet is moved use the velcro patches to secure it against the helmet.
- To avoid damage to the camera, the mount lock at the base must be loosened before twisting the camera.

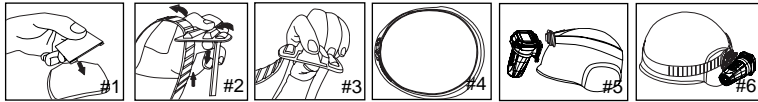

### Mounting the camera using the velcro strap:

- Attach the rubber patch to the bottom of the helmet grip.
- +3. Place the helmet grip on the helmet, and thread the velcro strap through the helmet grip.
- Secure the velcro strap by fastening it through the helmet vents.
- Slide the camera into the helmet mount grip, and adjust the angle of the camera making sure it is secure.

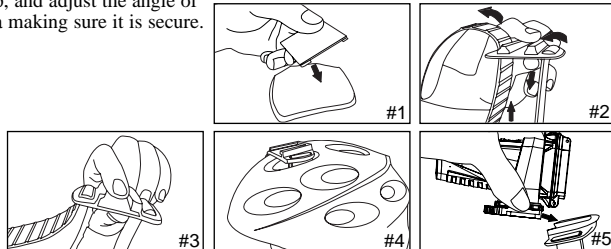

### Mounting the camera using the handlebar grip:

- Place the handlebar grip on the handlebar.
- Add the screw and nut to hold the handlebar grip securely.
- Slide the camera into the handlebar grip and make sure the handlebar grip is locked with the camera.
- Adjust the angle of the camera.

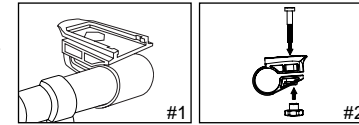

### Mounting the camera on a tripod or camera mount:

- Attach the tripod mount to the bottom of the camera.
- With the tripod mount on the camera, screw it onto the webcam stand.
- Adjust the angle of the camera.

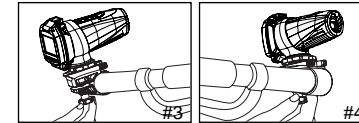

## VII) Camera Usage

### Battery Installation

**⚠ Use Caution, the edge of the base clip may be sharp.**

When opening the cover make sure the clip is in the same direction as the lens. Observe the following precautions when opening the end of the camera:

- Unlock the rear of the unit by squeezing the black release buttons whilst lifting the latch.
- Use a coin or screwdriver to turn the screw anti-clockwise to release the battery door.
- Insert 2 x AA alkaline batteries into the battery slot with the polarity in the direction as shown.
- Close the battery slot door and ensure the screw is tight before closing and locking the latch.

**Note:** When the battery is low, the low battery icon will appear on the LCD screen. Please ensure you save your recording and then change the old batteries for new ones.<sup>(3)</sup>

**Always upload video footage to your PC prior to replacing batteries to avoid memory loss**

**Note:**

- Do not mix old and new batteries together. Replace both batteries at the same time.
- Remove the batteries if the camera is not going to be used for extended periods of time.
- Do not mix alkaline, standard (carbon-zinc) or rechargeable (nickel-cadmium) batteries. Only batteries of the same or equivalent type as recommended are to be used together.
- Do not touch the flat cable at the back of the camera.

### Remote Control Battery Installation

The battery compartment is located on the underside of the controller. Use a coin to twist the cap lock anti-clockwise then lift the cover off. Insert the battery ensuring the negative polarity direction is placed on the metal prong.

Replace the cover and use a coin to screw it clockwise ensuring it is firmly closed.

### Turning the Camera On

1. Press and hold the On/Off Button  for 2 seconds (one beeping sound). The LED will be green indicating the camera is on. The LCD screen will show the remaining time.
2. For your safety, do not press any buttons on the camera during sports activities.



### Turning the Camera Off

1. Press and hold the On/Off Button  for 2 seconds (two beeping sounds). The LCD screen will turn off. The LED will be blank indicating the camera is off.
2. The camera will be turned off automatically after 30 minutes of not being used unless it is in USB mode. When the camera is off the LED will always be blank.

**Note:** If the camera is connected to your PC, you have to unplug the USB cable to turn the camera off.

**Note:** Ensure that the ATC5K is turned off during the insertion or the removal of the SD card. The card and the data may be damaged if the SD card is inserted or removed while the camera is on.

This product does not have battery recharge capabilities. Do not attempt to recharge batteries in this product as it may cause damage or injuries.

### SD card insertion/removal

#### Insert:

1. Turn the ATC5K off .
2. Unlock the end latch to open the ATC5K.
3. Ensure the SD card connect terminals are facing down then insert it carefully and completely until it clicks in place.
4. Close the camera and lock the latch.



#### Remove:

1. Turn the ATC5K off .
2. Unlock the end latch to open the ATC5K.
3. Push the card until it clicks, then pull the card out.
4. Close the camera and lock the latch.







#### Note:

- a. Ensure the card is inserted correctly.
- b. Do not touch the connect terminals on the back of the SD card.

- c. The card may be damaged if it is not fully inserted.
- d. The card and the data may be damaged if the SD card is inserted or removed while the camera is on.

### Taking Video Footage

1. Aim at what you want to record.
2. Press and hold the “Movie shutter button”  for 2 seconds to start recording (one beeping sound). The LED will change from green to red to indicate that it is recording. The time elapsed will be shown on the LCD screen.
3. Press and hold the “Movie shutter button”  again for 2 seconds to stop recording (two beeping sounds). The length of the video footage will show on the LCD screen for 2 seconds, after which the remaining time will be shown (the remaining time is an estimate only). The LED will change from red to green to indicate it has stopped recording but is still on.
4. Press the Menu button  to select the desired resolution (640 x 480, 320 x 240). Press the Menu button  again to shift through the icons representing these resolutions (at the top of the LCD screen), as described on page 9. You must press “Confirm”  to verify your selection.

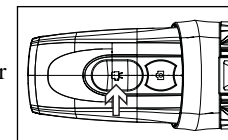



EN

### Warning:

When the low battery warning appears please change the batteries in the camera to avoid any accidental memory loss or file corruption.







### Using the Remote Control

1. Ensure you are pointing the remote control sensor towards the camera sensor. Press either the remote control “Movie shutter button”  or the “Photo capture button” .
2. The LED on the camera will change from green to red to show recording has begun.
3. The remote control has a limited range. We recommend using the remote control within 4m of the camera if the control is pointed straight. If the control is being pointed at an angle we recommend users stay within a 2m radius and limit the projection angle to within 20° left/right of the IR receiver.

### Note:







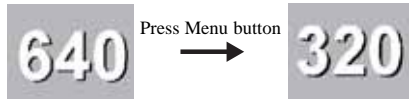
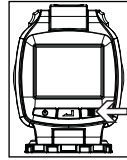



1. Default resolution is 640 x 480 (VGA).
2. If the recording time is long, the video file may be separated into multiple files automatically. The user does not need to monitor this process, the camera will resume filming once the file is saved (after a couple of seconds). Please note that the time duration needed to save video files may vary depending upon the length of the file. Please be patient during this process.

















### VIII) Menu Settings

1. Press and hold the Menu button  for 2 seconds (one beeping sound) to start selecting options. The menu icons will be shown on the LCD screen. Please refer to the table below for the icon details.
2. You can shift through different shooting modes by pressing the Menu button  repeatedly. The LCD will show each mode as you are on you press the Menu button .
3. Press the “Confirm” button  to confirm the selection  (one beeping sound).
4. Once inside a menu mode use the Menu button  to scroll between the options. You need to make a selection to exit that stage of the menu.
5. When you want to exit the Menu Selection mode, shift through the icons by pressing the Menu button  repeatedly. Alternatively you can hold Menu down for 2 seconds. This will exit menu mode.







6. The different mode icons are shown in the table below.



Icon	Title	Description
	Resolution	Select the recording resolution
	High resolution (640x480 pixels)	Large video format/ less storage capability
	Medium resolution (320x240 pixels)	Medium video format
	Playback	View videos or photos from the SD card or internal memory
	Photo	Review photos
	Video	Review videos
	Privacy mode OFF	Enables button and buzzer sounds
	Privacy mode ON	Disables button and buzzer sounds
	Sound and High volume	Level of audio recording is high
	Low volume	Level of audio recording is low



Icon	Title	Description
	Volume off	Audio recording is off
	Date and Time	Set the date and time
	Time	Change the time
	Date	Set the date
	Delete	Allows users to delete files
	Delete the last file	Erases the last file stored
	Delete all files	Erases all files on SD or internal memory
	File	Review files on memory
	Webcam	Use the ATC5K as a webcam
	Viewfinder	Connect the camera to TV or PMP to view realtime footage
	Previous	Review previous file
	Pause/Play	Pause/Play the file you are reviewing
	Stop	Stop playing the file you are reviewing
	Next	Review next file
	Delete (playback mode)	Whilst in playback mode delete the file you are currently viewing
	SD card	SD card is inserted in the camera
N/A	Low battery	Battery is low





### Playback on LCD









Press the Menu button , the first icon is the  icon. Press the “Confirm” button  to enter this menu mode or press Menu  again to move onto the next mode, Resolution .



This mode allows the user to review files stored in the memory.

Press "Menu"  to go onto the next menu mode - Resolution .

Or, press "Confirm"  to enter Playback Mode .

There are 2 options in Playback Mode, review photos  and review videos . Press "Menu"  to switch between the two and press "Confirm"  to select your option.



Once in either of these modes the playback options are the same: Previous , Pause/Play , Stop , Next  and Delete . To move along the icons press the "Menu" button , once on the desired icon press "Confirm" . If Delete  is selected only the file you are currently reviewing will be deleted. To delete all please see the Delete section in this manual.



To exit Playback Mode  hold the "Menu" button  for 2 seconds this will bring you back to the viewfinder ready to record.



### Resolution

#### 640 x 480, 320 x 240 pixels resolution

This camera allows you to choose from two video resolutions:

 640 x 480 and  320 x 240. These will be shown as 640 - high resolution and 320 - low resolution. High resolution video footage has better quality because it has more pixels. Lower resolution has fewer pixels but enables the user to record for a longer period of time.

The duration of video footage your camera can take depends on the resolution you choose. To switch between high resolution, 640, and medium resolution, 320, press the Menu button  until the LCD screen shows the correct icon. Press the 'Confirm' button  to confirm your selection.

Item	Picture size	fps
VGA 	640 X 480 pixel	30
QVGA 	320 X 240 pixel	30



### Privacy Mode

This mode allows the user to disable the sound features.

The privacy icon  will be highlighted.





Press “Menu”  to go onto the next menu mode – Sound Recording.





Or, press “Confirm”  to enter the privacy mode.

Whilst on this icon , pressing confirm will turn button sounds and LED lights ON. Selecting this icon  will turn all button sounds and LED lights OFF but still record audio.



When in privacy mode option, pressing “Menu” will change between ON and OFF. This will be looping. You must confirm one of the choices to move onto the next menu mode.

### Sound Recording







Once you have entered this mode the icon will be highlighted and  will be shown on screen.  means sound is being recorded during filming but at a low volume. Press Menu  (one beeping sound) to switch to , which means no sound will be recorded.

After , it will loop back to  - which means sound is being recorded at high volume - when 'Menu'  is pressed again. Press the “Confirm” button  (one beeping sound) to confirm the setting and to go to the next function icon.



### Setting Date/Time (Clock Set)

Shift to the Date icon in the Menu mode by pressing the Menu button  repeatedly until the icon is reached. When the Date icon is highlighted, press the “Confirm” button  to change the date and time.



### Setting the Year

1. Press the “Menu button”  to adjust the last digit of the year (00-09).  
Press the “Confirm” button  to verify the last digit.
2. Press the “Menu button”  to adjust the 3rd digit of the year (0X-9X).  
Pressing “Confirm”  will then move the cursor to allow you to adjust the 3rd digit of the year. Press the “Menu” button  to select the number and the “Confirm” button  to verify, after which you will be able to adjust the month.



### Setting the Month



When adjusting the month, “MM” will be shown. Press the “Menu button”  to adjust the month. Press the “Confirm” button  to verify, after which you would be able to proceed to setting the date.

### Setting the Date

When adjusting the date, "DD" will be shown. Press the "Menu button"  to adjust the date. Press the 'Confirm' button  to verify, after which you would be able to proceed to setting the time.





### Setting the Time

Press the "Menu button"  to adjust the hour. Press the "Confirm" button  to verify the hour, after which you would be able to proceed to setting the minute.

Press the "Menu button"  to adjust the minute. Press the "Confirm" button  to verify the time and exit this mode.

**Note:** Time will be shown in 24 hour format.



### Deleting individual files

The Delete icon looks like this . Once inside the delete menu to delete the last file that was recorded, press the Menu button  until the LCD screen shows . Press the Confirm button  to confirm.

Repeat these two steps to individually delete your files.

**Note:** After file deletion, the LCD screen will adjust the remaining number of files accordingly.

### Delete All files

To delete all files stored in your camera, press the Menu button  until the LCD screen shows . Press the Confirm button  to verify.

**Note:** It may take a few minutes to delete multiple files at one time.

### SD Memory Card

In this unit, you can use SD Memory Cards of up to 4GB.

To use an SD memory card, turn off the ATC5K and insert the SD memory card. When the camera is turned on again the SD card icon  will be displayed on the LCD screen.

The remaining time on the SD card will also be displayed on the LCD screen. All of the video footage will now be saved onto the SD card.

#### Note:

1. If there is an error on the SD memory card, the SD card icon and the letters "Err" will be displayed on the LCD screen. In this case, turn off the camera and remove the SD card.
2. The SD card is equipped with a Write-Protect switch that can prevent writing and formatting to the card. "Card Locked" will be displayed if the SD card is locked with Write-Protect switch.
3. We recommend using SanDisk regular or AData SD cards.
4. With use on Windows 2000 users must format to FAT otherwise the SD card and camera may malfunction.

### Available Recording Time







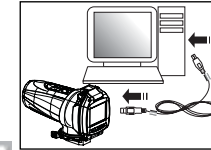

The available recording time is an approximation (these vary depending on the recording conditions and the type of card).

Picture quality setting	VGA 30 fps	QVGA 30 fps	
Internal Memory	32 MB	47 s	1 min 36s
SD Memory Card	1 GB	30 min	57 min
	2 GB	60 min	114 min
	4 GB	120 min	216 min

## IX) Connecting to a computer

You can upload your recorded video footage to a PC by connecting the ATC5K to your PC using the USB cable.



1. Turn the ATC5K on.
2. Connect the ATC5K to a PC via the USB cable.
3. There are 2 modes available, File  and Cam . File  allows you to check the files in the camera or SD card. Cam  is the webcam function.
4. Select Cam  to use the ATC5K as a webcam by pressing "Confirm"  whilst the icon  is highlighted. Please note that the software must be installed before using the webcam mode.
5. "File"  appears on the ATC5K LCD screen, which means ATC5K is connected to your PC and files are available for review.
6. To choose to review Files in the Camera/SD card the user should press "Confirm" . Once selected the ATC5K drive appears in the [My Computer] folder.  
\*If you are connecting the camera to a PC for the first time, the required driver is installed automatically so that the camera can be recognized by Windows Plug and Play. The 100ATC5K drive then appears on the [My Computer] folder.
7. Open the "100ATC5K" folder in the [DCIM] folder to start selecting your desired video files. Copy the desired video to your PC.

• Folder Composition:

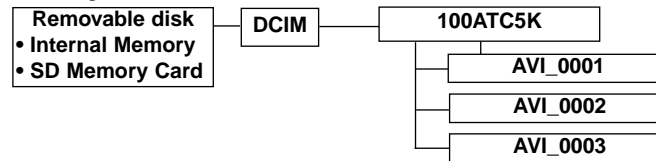



## X) Webcam installation

### Warning:

This hardware has not passed Windows Logo testing. Users may install the webcam feature but do so at their own risk. By installing the webcam feature users indemnify Oregon Scientific from any software, hardware or virus problems caused as a result of installation.

### Attention:

- \*Webcam Installation does not work with Vista 64 bit versions.
- \* With use on Windows 2000 users must install Netmeeting in order to use the webcam feature.

### Webcam Installation on Windows Vista

Note: Before installing the software please ensure the CD is in the CD drive.

1. With the USB cable inserted and camera on, press the Menu button to select "Cam" on the LCD screen and then press "Confirm". A pop-up window will appear. Select "Locate and install driver software (recommended)". After this you will be asked for permission to continue installation - click "Continue".



2. Click "I don't have the disc. Show me other options".



3. Next select "Browse my computer for driver software (advanced)".



4. After following step 4 you should select browse, CD drive then click "Next".

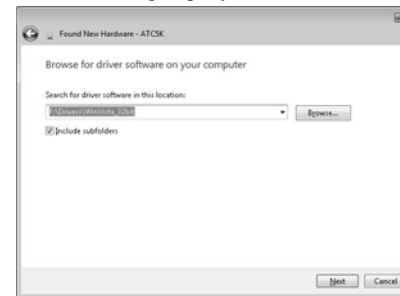

5. Select your CD drive then click "OK".



6. Select WinVista\_32bit then click "OK".



7. Ensure the path name is correct then click "Next".



8. When the Windows Security pop up window appears click "Install this software anyway" to continue installing.

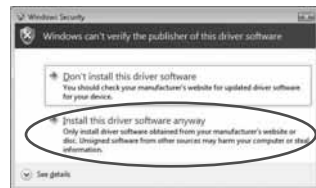

9. Congratulations the device is successfully installed.



### Webcam Installation Guide on Windows XP

Note: Before installing the software please ensure the CD is in the CD drive.

1. With the USB cable inserted and camera on, press the "Menu" button - "Cam" will be shown on the LCD screen - then press the "Confirm" button. A pop-up window will appear, select "Install from a list or specific location (Advanced)" then click "Next".



2. On the next window select "Include this location the search" and then click "Browse".



3. Select the "Drivers" folder from the CD.



EN

4. On the next window select “WinXP” then click “OK”.



5. Ensure the path name is correct and then click “Next”.

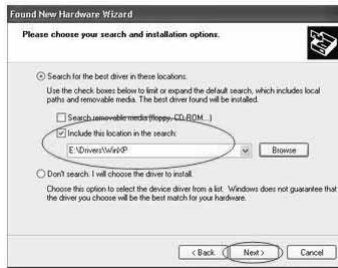

6. The next pop-up window will inform you that our camera has not passed Windows Logo Testing to verify its compatibility with Windows XP. Click “Continue Anyway”.



7. Your OS Digital Camera is now installed, click “Finish” and wait for the next pop up window.



8. The pop up window should be the same as in step 1. Please follow steps 1-9 again. Once this is complete your OS Video Camera will be installed and your ATC5K webcam will be ready to use.



### Webcam Installation on Windows 2000

Note: Before installing the software please ensure the CD is in the CD drive.

1. With the USB cable inserted and camera on, select “Cam” on the LCD screen. A pop-up window will appear. Select “Next”.



2. Select "Display a list of the known drivers for this device so that I can choose a specific driver".



3. On the next window select "Other devices" then click "Next".



4. On the next window click "Have Disk" then select the CD drive.



5. Select Win2000 from the CD drive then select the icon named "OSUsb" before clicking "Open".



6. Ensure the path name is correct then click "OK".

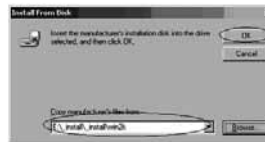

7. Select "OS Digital Camera" then click "Next".

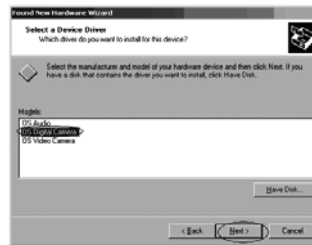

8. When the next window appears click "Next".



9. At this window click the “Yes” button.



10. Your hardware is now installed. Click “Finish”.



11. Once you click “Finish” the Video Capture Device will begin installing. Repeat the above steps until that has been installed.



12. When in the Win2000 folder in the CD remember to select OSVid, not OSUsb.







13. Click “Next” after selecting the OS Video Camera.



14. Once you have finished installation your camera will be ready to use as a webcam.







## XI) Webcam / USB mode

- To use the Webcam function, whilst the mode is in File , press “Menu” . This will change the mode to Cam . Press “Confirm”  to select. Once selected the computer will recognise the camera as a webcam.
- While in either mode, to change to the other, users must disconnect from their PC and reconnect going through the entire selection procedure again.
- The camera will use power from the computer.

### Note:

- Videos will be saved in AVI format.
- When the ATC5K is connected to the PC with an SD card inserted in the camera, the “100ATC5K” folder will show the files on the SD card.
- Webcam mode is not available with Apple Mac.

You can upload your recorded video footage to a MAC by connecting the ATC5K to your MAC using the USB cable.



















- Turn the ATC5K on.
- Connect the ATC5K to a MAC via the USB cable.
- There are 2 modes available, File  and Cam . File  allows you to check the files in the camera or SD card. Cam  is the webcam function.
- “File”  appears on the ATC5K LCD screen, which means ATC5K is connected to your MAC and files are available for review.
- To choose to review Files in the Camera/SD card the user should press “Confirm” . Once selected the ATC5K drive appears in the [My Computer] folder.  
\*If you are connecting the camera to a MAC for the first time, the required driver is installed automatically.

6. Open the "100ATC5K" folder in the [DCIM] folder to start selecting your desired video files. Copy the desired video to your MAC.
7. While in either mode, to change to the other, users must disconnect from their MAC and reconnect going through the entire selection procedure again.
8. The camera will use power from the computer.

### Note:

The ATC5K comes with a webcam stand. Please use this when using your ATC5K as a webcam.

## XII) Playing back video footage on a TV

1. Turn the ATC5K and TV off.
2. Connect your ATC5K to your TV using the AV cable.
3. Turn the TV and ATC5K on.
4. There are 2 modes available, Playback (PB)  and Viewfinder (VF) .
5. "PB"  appears on the LCD screen as default. To change to VF  press the "Menu" button  then "Confirm" . Once this mode is selected, a real time image will appear on your TV screen (or PMP). When in VF  mode all record functions are disabled. TV mode is automatically activated when the AV cable is connected to the ATC5K and TV.
6. If PB  mode is selected the function keys will be shown on the TV screen. The function keys include Previous , Pause/Play , Stop , Next  and Delete .
7. Press the Menu button  to move the highlight cursor along the function keys.
8. Press the Confirm button  when the desired function key is highlighted.
9. To delete one file, select the Delete-One icon  and confirm by pressing the Confirm button .
10. If "VF"  was selected a realtime view of what the camera sees should now be viewable on your TV or PMP. The use of buttons with record functions are disabled in this mode. To return to the menu simply unplug the AV cables.

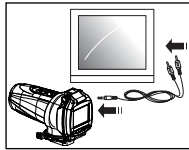

## XIII) Troubleshooting

### There's no display

- Are the batteries properly installed?
- Do the batteries need replacing?

### After the ATC5K is connected to my PC, it cannot find the new drive in the 'My Computer' folder

- Ensure each end of the ATC5K USB cable is properly and firmly connected.
- Ensure your USB port is working properly. Try connecting another USB device into the port. If the other device does not work, the USB port may have a malfunction. In this case, contact your system manufacturer or the manufacturer of your USB card.

### I can't capture video footage

- Ensure there is enough space on the internal memory of ATC5K or the SD card; the display will tell you how much time there is left for video recording.
- Ensure the SD card is not locked. The LCD will display a message if the SD card is locked.

### The remaining time is not accurate

- The remaining time is an estimate.
- The remaining time depends not only on the time recorded, but on the color density of the video footage. Under conditions with high contrast, such as outdoors, the actual time available will be less than under low-contrast conditions.

### I can't play the video footage on my television

- Ensure each end of the AV cable is properly and firmly connected to ATC5K and to your television.
- Ensure the ATC5K and television are both turned on.
- Ensure you have selected PB  to view files.

### Some captured video footage cannot be found when SD card is inserted

- The video footage may be stored on the internal memory. Connect the ATC5K to your PC without an SD card, and it will show the files in the internal memory.

### The sound is very low or there is no sound

- Ensure the audio is on by following the instructions in the Sound Recording section.

- The ATC5K is specifically designed for extreme sports and is waterproof, it is for this reason that we have made the microphone less sensitive.

### Further Help

We make every effort to ensure the accuracy and appropriateness of the information provided on our products. We encourage you to contact our Technical Support Team at [atc@oregonscientific.com](mailto:atc@oregonscientific.com) with any problems and/or suggestions, or, call our Customer Service Department at 0871 222 1966. Our service representatives will be happy to help you.

**Please note that the Technical Support Team cannot issue or authorise any RMA's or replacements. For an RMA or replacement please contact our Customer Service Department.**



### Oregon Scientific (UK) Ltd.

Unit 1, Switchback, Gardner Road,  
Maidenhead, Berkshire SL6 7RJ.  
Hotline number: 0871 222 1966  
Email: [atc@oregonscientific.com](mailto:atc@oregonscientific.com)  
[www.oregonscientific.co.uk](http://www.oregonscientific.co.uk)



This device complies with Part 15 of the FCC Rules. Operation is subject to the following two conditions:  
(1) this device may not cause harmful interference, and (2) this device must accept any interference received, including interference that may cause undesired operation.

#### WARNING:

Changes or modifications to this unit not expressly approved by the party responsible for compliance could void the user's authority to operate the equipment.

#### NOTE:

This equipment has been tested and found to comply with the limits for a Class B digital device, pursuant to Part 15 of the FCC Rules. These limits are designed to provide reasonable protection against harmful interference in a residential installation. This equipment generates, uses, and can radiate radio frequency energy and, if not installed and used in accordance with the instructions, may cause harmful interference to radio communications. However, there is no guarantee that interference will not occur in a particular installation. If this equipment does cause harmful interference to radio or television reception, which can be determined by turning the equipment off and on, the user is encouraged to try to correct the interference by one or more of the following measures:

- Reorient or relocate the receiving antenna.
- Increase the separation between the equipment and receiver.
- Connect the equipment into an outlet on a circuit different from that to which the receiver is connected.
- Consult the dealer or an experienced radio TV technician for help.

"This Class B digital apparatus complies with Canadian ICES-003."

"Cet appareil numérique de la class B est conforme à la norme NMB-003 du Canada"

This product has passed JIS7 Standard for Waterproof Test.

This product has passed EN60065:2002 performance test for vibration.



#### INFORMATION FOR USERS

In accordance with European Directives 2002/95/CE, 2002/96/CE and 2003/108/CE on the restriction of the use of dangerous substances in electric and electronic equipment as well as their waste disposal.

The barred symbol of the rubbish bin shown on the equipment indicates that, at the end of its useful life, the product must be collected separately from other waste.

Therefore, any products that have reached the end of their useful life must be given to waste disposal centres specializing in separate collection of waste electrical and electronic equipment, or given back to the retailer at the time of purchasing new similar equipment, on a one for one basis.

The adequate separate collection for the subsequent start-up of the equipment sent to be recycled, treated and disposal of in an environmentally compatible way contributes to preventing possible negative effects on the environment and health and optimises the recycling and reuse of components making up the apparatus.

Abusive disposal of the product by the user involves application of the administration sanctions according to the laws in force.