

DIGITAL WEATHER FORECASTER WITH REMOTE THERMO-HYGRO SENSOR AND RADIO CONTROLLED CLOCK

MODEL NO.: BAR122HG

USER'S MANUAL

INTRODUCTION

Congratulations on your purchase of the Weather forecaster with cable free sensor and radio-controlled calendar clock (BAR122HG).

This unit has a large four-line liquid crystal display (LCD) for displaying weather forecast information, in/outdoor temperatures and relative humidity, radio frequency (RF) controlled calendar clock, clock display of 2nd time-zone and dual daily alarms. Also, the main unit can support up to three remote sensors.

Other features include weekday display in four abbreviated languages, four-step crescendo alarm and interchangeable clock display modes.

MAIN FEATURES: MAIN UNIT

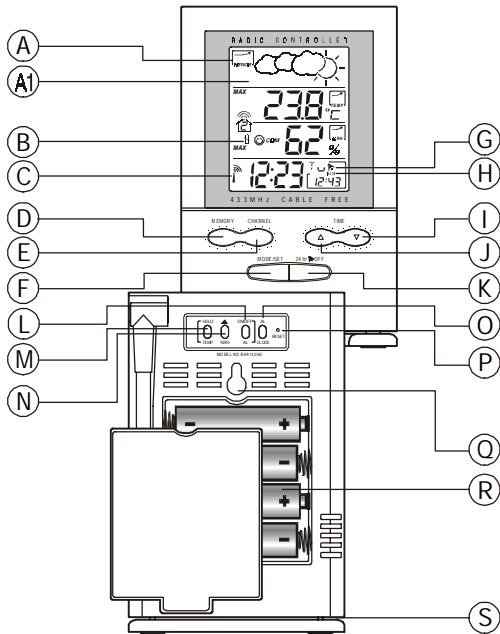

A. FRONT DISPLAY

A four line easy-to-read LCD

A1. WEATHER FORECAST WINDOW

Graphically illustrates a weather forecast

B. [] BATTERY-LOW INDICATOR

Activates when the remote-sensor or main unit battery power is low

C. [] RADIO-RECEPTION SIGNAL

Indicates the condition of radio reception

D. [MEMORY] BUTTON

Displays minimum and maximum temperature and humidity readings, and erases memory data

E. [CHANNEL] BUTTON

Toggles among the remote sensor channels

F. [MODE/SET] BUTTON

Changes the display mode of the clock and alters time/date setting

G. [] / [] ALARM-ON ICONS

Appears when the alarm is activated

H. [((1))] / [((2))] ALARM ICONS

Appears when the alarm time is displayed

I. [TIME ▽] BUTTON

Decreases the value of a setting

J. [TIME △] BUTTON

Advances the value of a setting

K. [24 hr  OFF] BUTTON

Displays the alarm time, or changes the alarm set time

L. [ON/OFF] BUTTON (TEMP/% RH ALARM)

Enables / disables HI/LO temp alarm and HI/LO % RH alarm

M. [HI/LO] BUTTON (TEMP/% RH ALARM)

- Set the upper or lower temperature alarm limits of individual channels
- Confirms alarm settings

N. [▲] BUTTON (TEMP/% RH ALARM)

Sets the readings for the upper or lower temperature and humidity of individual channels

O. [AL CLOCK] BUTTON

Enables or disables the daily alarms

P. [RESET] BUTTON

Returns all settings to default values

Q. WALL-MOUNT HOLE

For mounting the unit on a wall

R. BATTERY COMPARTMENT

Accommodates four (4) UM-3 or “AA” size batteries

S. REMOVABLE TABLE STAND

For standing the main unit on a flat surface

FEATURES: REMOTE THERMO-HYGRO SENSOR

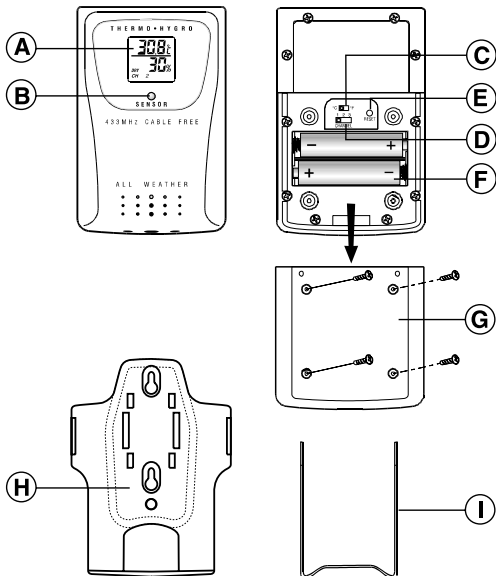

A. TWO-LINE LCD

Displays the current temperature and humidity monitored by the remote unit

B. LED INDICATOR

Flashes when the remote unit transmits a reading

C. °C/°F SLIDE SWITCH

Selects between Centigrade (°C) and Fahrenheit (°F)

D. CHANNEL SLIDE SWITCH

Designates the remote unit Channel 1, Channel 2 or Channel 3

E. RESET

Returns all settings to default values

F. BATTERY COMPARTMENT

Accommodates two AAA-size batteries

G. BATTERY DOOR

H. WALL-MOUNT HOLDER

Supports the remote unit in wall-mounting

I. REMOVABLE TABLE STAND

For standing the remote unit on a flat surface

BEFORE YOU BEGIN

For best operation,

1. Assign different channels to different remote units.
2. Insert batteries for remote units before doing so for the main unit.
3. Place the main unit as close as possible next to the remote unit, reset the main unit after installing batteries. This will ensure

easier synchronization between the transmission and reception of signals.

- Position the remote unit and main unit within effective transmission range, which, in usual circumstances, is up to 100 meters.

Note that the effective range is vastly affected by the building materials and where the main and remote units are positioned. Try various set-ups for best result.

Though the remote units are weather proof, they should be placed away from direct sunlight, rain or snow.

BATTERY INSTALLATION: MAIN UNIT

- Gently lift up the tab on the battery compartment door.
- Insert four UM-3 or “AA” size alkaline batteries.

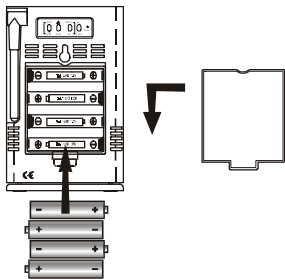

- Replace the battery compartment door.

BATTERY AND CHANNEL INSTALLATION: REMOTE UNIT

The remote thermo-hygro sensor unit uses two (2) UM-4 or “AAA” size alkaline batteries.

Follow these steps to install / replace batteries:

- Remove the screws on the battery compartment.
- Select the channel number on the [CHANNEL] slide switch.
- Select the temperature display unit on the °C/°F slide switch.

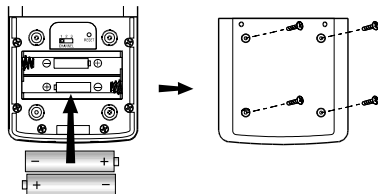

- Insert the batteries strictly according to the polarities shown therein.
- Replace the battery compartment door and secure its screws.

Replace the batteries when the low-battery indicator of the particular channel lights up on the main unit. (Repeat the steps described in section “BEFORE YOU BEGIN”)

Note that once a channel is assigned to a remote unit, you can only change it by removing the batteries or resetting the unit.

LOW BATTERY WARNING

When it is time to replace batteries, the respective low-battery indicator will show up when the respective channel is selected. The battery level of the main unit will be shown on the indoor temperature when it is running low.

HOW TO USE THE TABLE STAND OR WALL MOUNTING

The main unit has a removable table stand, which when connected, can support the unit on a flat surface. Or you can remove the stand and mount the unit on a wall using the recessed screw hole.

As for the remote unit, it comes with a wall-mount holder and a removable stand. Use either to hold the unit in place.

Main unit

Wall-mount

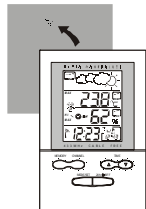
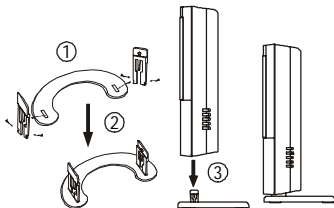

Table Stand



Remote unit

Wall-mount



Table Stand

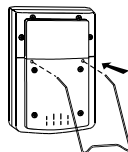

THE RESET BUTTON

This button is only used when the unit is operating in an unfavorable way or malfunctioning. Use a blunt stylus to hold down the button. All settings will return to their default values.

GETTING STARTED

Once batteries are placed in a given remote sensor unit, it will start transmitting information at 40-second intervals.

Also, for approximately a 3-minute duration, the main unit will automatically search for signals once batteries are installed. Upon successful reception, the individual channel temperature reading will be displayed on the top line and the respective humidity reading on the bottom line. The main unit will automatically update its readings at about 40-second intervals.

If no signals are received, blanks “---” will be displayed and the kinetic wave icon will not show.

To force a signal search:





- Press and hold [CHANNEL] & [MEMORY] for 2-seconds to enforce a 3-minute search.

This is useful in synchronizing the transmission and reception of the remote and main units.

Repeat this step whenever you find discrepancies between the reading shown on the main unit and that on the respective remote unit.

HOW TO CHECK REMOTE AND INDOOR TEMPERATURE & HUMIDITY

Display of readings from a remote sensor or the main unit is a one-step procedure. The remote sensor channel or the main unit display is indicated in a box under the kinetic-wave icon.

Kinetic-wave Icon				
Designated Display	Indoor Display	Remote Display Channel 1	Remote Display Channel 2	Remote Display Channel 3

To display temperature / humidity readings from the main unit:

- Press [CHANNEL] until a dot is displayed in the box under the kinetic-wave.

To display temperature / humidity readings from a remote sensor:

- Press [CHANNEL] until the appropriate remote sensor channel is displayed in the box under the kinetic-wave.

DISCONNECTED SIGNALS

If without obvious reasons the display for a particular channel goes blank, press [CHANNEL] & [MEMORY] to enforce an immediate search.

If that fails, check:

- The remote unit of that channel is still in place.
- The batteries of both the remote unit and main unit. Replace as necessary.

Note that when the temperature falls below freezing point, the batteries of outdoor units will freeze, lowering their voltage supply and the effective range.



- The transmission is within range and path is clear of obstacles and interference. Shorten the distance when necessary.

TRANSMISSION COLLISION

Signals from other household devices, such as door bells, home security systems and entry controls, may interfere with those of this product and cause temporarily reception failure. This is normal and does not affect the general performance of the product. The transmission and reception of temperature readings will resume once the interference recedes.

HOW TO READ THE KINETIC WAVE DISPLAY

The kinetic wave display shows the signal receiving status of the main unit. There are three possible forms:

The unit is in searching mode.	
Transmission data are securely registered.	
No signal received in search mode.	

REMOTE SENSOR SCANNING

The unit can be set to automatically scan and display readings from the remote sensors and indoor readings. When the remote-sensor mode is active, the display will show the readings from one channel for about 4-second and then proceed to the next channel display.

To activate the remote-sensor scanning mode:

- Press and hold [CHANNEL] for 2-seconds.

To deactivate the remote-sensor scanning mode:



- Press either [CHANNEL], [MEMORY], [HI/LO], [▲], [ON/OFF]

(TEMP % RH AL)

THE COMFORT-LEVEL ICONS



The comfort level indicators COMFORT, WET or DRY will tell you if the current environment is comfortable, too wet or too dry.



The comfort indicator will appear on the display when the following conditions are satisfied:



Indicator displays on the unit	Temperature Range	Humidity Range	Shows that the Current Environment
 COMFORT	20°C to 25°C (68°F to 77°F)	40%RH-70%RH	Ideal range for both relative humidity and temperature
 WET	-5°C -+ 50°C (23°F - 122°F)	OVER-70%RH	Contains excess moisture.
 DRY	-5°C -+ 50°C (23°F - 122°F)	Below 70%RH	Contains inadequate moisture
No Indicator	Less than 20°C(68°F) or More than 25°C (77°F)	40%RH to 70%RH	No comment

TEMPERATURE, HUMIDITY & PRESSURE TREND INDICATORS

The temperature-trend, humidity-trend and pressure trend indicators show the trends of collected readings. Arrows indicate a rising, steady or falling trend.

Arrow indicator			
Temperature Trend	Rising	Steady	Falling

Arrow indicator			
Humidity Trend	Rising	Steady	Falling

Arrow indicator			
Pressure Trend	Rising	Steady	Falling

Note: If the readings goes above or below the measuring range of the main unit or the remote unit (stated in specification), the display will show “**HHH**” or “**LLL**”.

MAXIMUM AND MINIMUM TEMPERATURE AND HUMIDITY

The maximum and minimum recorded temperature and humidity readings will automatically be stored in the memory.

To display the maximum and minimum display memory:

1. Select the channel to be checked.
2. Press [**MEMORY**] once to display the maximum temperature and humidity and again the minimum temperature and humidity. The respective indicators, MAX or MIN will be displayed.

To clear the memory:

- Press and hold [**MEMORY**] for 2-seconds.

If you press [**MEMORY**] now, the maximum and minimum recordings will have the same values as the current ones until different readings are recorded.

HOW TO USE CHANNEL-1 TEMPERATURE/ HUMIDITY ALARM

Upper and lower temperature and humidity limits for channel-1 can be set so that an alarm activates when the limits are exceeded.

The high and low temperature and humidity displays are selected by sequentially pressing **HI/LO**.

The high-low displays are as follows:

Sequence	Respective Display
Pressing HI/LO once	Enters HI temperature display
Pressing HI/LO twice	Enters HI humidity display
Pressing HI/LO third time	Enters LO temperature display
Pressing HI/LO fourth time	Enters LO humidity display

To set a high or low temperature or humidity alarm:

1. Press [**HI/LO**], channel-1 will be displayed.
2. Press [**▲**] to set the temperature or humidity limit. Each press will increase increments by one degree or percentage. Press and hold the button for a rapid-scrolling sequence by increments of five.

Note: The **temperature** range is from -50°C (-58°F) to +70°C (158°F).

If this is the first time you set the limits, the lower limit will start from -50°C (-58°F) and the upper limit +70°C (158°F). Other wise, the reading will start from the temperature last selected.

The **humidity** range is from 2% to 98%.

If this is the first time you set the limits, the lower limit will start from 2% and the upper limit 98% Otherwise, the reading will start from the humidity last selected.

3. Repeat the steps to set the upper humidity setting and the lower temperature and humidity settings.
4. When finished, press [**HI/LO**] to set another limit or wait 16-seconds. The unit will automatically return to the normal display.

The respective HI, LO or both indicators will light up to signify the status of the alarm.

If in another channel other than channel one is selected, when the alarm activates the display will switch to channel-1 and the display will flash. If left untouched, the alarm will activate for a 1-minute. Press [**CHANNEL**],[**MEMORY**],[**HI/LO**],[**▲**],[**ON/OFF**] to

(TEMP % RH AL)

momentarily stop the alarm. The alarm will activate again if the limit continues to exceed the set limit.

Note: If a second limit is passed while an alarm is active, the first alarm will complete its 1-minute cycle and the alarm will continue to activate for a second minute to indicate that a second limit has been surpassed.

To disable an alarm:

1. Enter the setting mode by pressing [**HI/LO**].
2. Then, press [**ON/OFF**].

The alarm has been disabled and will not sound at the previously set limit.





To disable a sounding alarm:

- Press either [**CHANNEL**],[**MEMORY**],[**HI/LO**],[**▲**],[**ON/OFF**]

(TEMP % RH AL)

WEATHER FORECAST FUNCTION

The unit is capable of detecting atmospheric pressure changes. Based on collected data, it can predict the weather for the forthcoming 12 to 24 hours. The effective range covers an area of 30 to 50 km.

Indicator displays on the unit				
Forecast	Sunny	Slightly Cloudy	Cloudy	Rainy

NOTE:

1. The accuracy of a general pressure-based weather forecast is about 70% to 75%.
2. The weather forecasts from this unit are predictions that cover the next 12 to 24 hours. It may not necessarily reflect the current situation.
3. The “Sunny” icon, as applies to nighttime, implies clear weather.

CALENDAR CLOCK DISPLAY MODES

The BAR122HG supports four time display modes in the sequence of:

MODE 1. Hour-Minute-Second (of local time)

Day-Month (of local time)

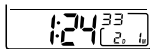
**MODE 2.** Hour-Minute-Day of the Week (of local time)

Day-Month (of local time)

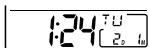
**MODE 3.** Hour-Minute-Day of the Week (of local time)

Hour-Minute (of alternate time zone)

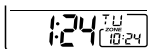
**MODE 4.** Hour-Minute-Day of the Week (of second time zone)

Day-Month (of alternate time zone)

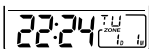

Each press on the [MODE/SET] button will toggle the display in the above order.

Note: The bottom line of the display will be replaced by the alarm time if the [24 hr OFF] button is pressed.

ABOUT RADIO RECEPTION





The BAR122HG is designed to automatically synchronize its calendar clock once it is brought within range of the Frankfurt DCF77 radio signal.

When the BAR122HG is within range, its radio-control mechanism will override all manual settings.

When the unit is receiving radio signal, the RADIO RECEPTION signal will start to blink. A complete reception generally takes about two to 10 minutes, depending on the strength of the radio signal.

When the reception is complete, the RADIO RECEPTION signal will stop blinking. The strength of the reception will remain until the next scanning cycle backs place.

For better reception, place the clock away from metal objects and electrical appliances to minimize interference.

	- Strong
	- Weak
	- No signal
	- Receiving

If you wish to disable the auto-reception feature, press the [**TIME / ▽**] button for three seconds. The radio reception signal [] will disappear. The unit will not respond to radio signals.

To enable the feature again, press the [**TIME / △**] button for three seconds.

The radio reception signal [] will start blinking to initiate reception automatically.

HOW TO SET THE CLOCK MANUALLY

To set the clock manually, hold [**MODE/SET**] for three seconds. The hour digits will blink.

Press [**TIME / △**] or [**TIME / ▽**] select the hour. Keep pressing the button to increase or decrease the value rapidly.

Press [**MODE/SET**] to confirm. The minute digits will blink.

Repeat the same procedure to set the minutes, hour, current day, month, display language, weekday and hour offset for the 2nd time zone.

Note: The time and date are displayed in 24-HOUR clock format. For the language display, you can choose among English (E), German (D), French (F) and Italian (I). Weekday is in the usual sequence of Monday through Sunday.

For the 2nd time zone, which is indicated by the ZONE icon, enter the hour offset using the [**TIME / △**] and [**TIME / ▽**] buttons and the BAR122HG will calculate the second zone-time accordingly.



If there is an item you do not wish to change, simply press [**MODE/SET**] to bypass the item.



When you are done, press [**MODE/SET**] to exit. The display will return to the mode last chosen.

HOW TO SET AND ARM THE ALARMS

The BAR122HG has two alarms, ALARM 1 and ALARM 2. They can be invoked together or independently.

To set an alarm:

1. Press [**24 hr**  **OFF**] once to select ALARM 1 or again to select ALARM 2. The last selected time of the alarm will be displayed. If you have never set the alarm before, the time will be displayed as 0:00.
2. Press [**24 hr**  **OFF**] for three seconds. The hour digits will blink.

3. Enter the hour using [**TIME** / \triangle] and [**TIME** / ∇].
4. Press [**24 hr**  **OFF**]. The minute digits will blink.
5. Enter the minutes using [**TIME** / \triangle] and [**TIME** / ∇].
6. Press [**24 hr**  **OFF**] to exit. The [] icon for the alarm chosen will be displayed indicating the alarm set above is now armed.

You can also arm or disarm an alarm by pressing the [**AL CLOCK**] button.

When an alarm is armed, it will go off at the set time.

The four-step crescendo function allows the alarm to start off gently and step up its intensity every 20 seconds for four times. Without interruption, the alarm will go off for a total of two minutes. If no key is pressed to turn off the alarm within these 2 minutes, the alarm will go off once more after 8 minutes.

If a second alarm goes off when the first alarm is sounding off, the first alarm will be disabled automatically.

HOW TO STOP AN ALARM

To stop an alarm, you can use either press [**24 hr**  **OFF**] button or [**AL CLOCK**] button.

Pressing [**24 hr**  **OFF**] will stop the alarm, which is still armed and will activate at the set time the following day.

If [**AL CLOCK**] button is pressed instead, the alarm will be stopped and deactivated all together.

MAINTENANCE

When handled properly, this unit is engineered to give you years of satisfactory service. Here are a few product care instructions:

1. Do not immerse the unit in water. If the unit comes in contact with water, dry it immediately with a soft lint-free cloth.
2. Do not clean the unit with abrasive or corrosive materials. Abrasive cleaning agents may scratch the plastic parts and corrode the electronic circuit.
3. Do not subject the unit to excessive: force, shock, dust, temperature, or humidity. Such treatment may result in malfunction, a shorter electronic life span, damaged batteries, or distorted parts.
4. Do not tamper with the unit's internal components. Doing so will terminate the unit's warranty and may cause damage. The unit contains no user-serviceable parts.
5. Only use new batteries as specified in this instruction manual. Do not mix new and old batteries as the old batteries may leak.
6. Read this instruction manual thoroughly before operating the unit.

SPECIFICATIONS

Temperature Measurement

Main unit

Indoor Temperature measurement

Proposed operating range : -5.0°C to +50.0°C
(23.0°F to 122.0°F)

Temperature resolution	: 0.1°C (0.2°F)
Relative Humidity Operating range	: 25% RH to 90% RH

Remote thermo-hygro unit

Proposed operating range	: -20.0°C to +60.0°C (-4.0°F to 140.0°F)
--------------------------	---

Temperature resolution	: 0.1°C (0.2°F)
Relative Humidity Operating range	: 25% RH to 90% RH

Power

Main unit	: use four (4) UM-3 or “AA” 1.5V alkaline battery
Remote sensing unit	: use two (2) UM-4 or “AAA” 1.5V alkaline battery

Weight

Main unit	: 216gm (without battery)
Remote sensing unit	: 63 gm (without battery)

Dimension

Main unit	: 136 x 90 x 35 mm (L x W x D)
Remote sensing unit	: 92 x 60 x 20mm (L x W x D)

NOTE ON COMPLIANCE

Warning: Changes or modifications to this unit not expressly approved by the party responsible for compliance could void the user's authority to operate the equipment.

R&TTE Compliance Note

This device complies with the essential requirements of Article 3 of the R&TTE 1999/5/EC Directive, if used for its intended use and that the following standard(s) has been applied:

Electromagnetic compatibility (Article 3.1.b of the R&TTE Directive)

Applied standards ETS 300 683 : 1997

Efficient use of the radio frequency spectrum (Article 3.2 of the R&TTE Directive)

Applied standards EN300 220 -1 : 1997

INTENDED USE OF THE DEVICE

CAUTION

- The content of this manual is subject to change without further notice.
- Due to printing limitation, the displays shown in this manual may differ from the actual display.
- The contents of this manual may not be reproduced without the permission of the manufacturer.

COUNTRIES RTTE APPROVAL COMPLIED:

Austria, Belgium, Denmark, Finland, France, Germany, Greece, Italy,
Luxembourg, Netherlands, Portugal, Spain, Sweden, UK and Ireland.